

激光及自动化综合解决方案提供商

COMPREHENSIVE SOLUTION SUPPLIER OF LASER & AUTOMATION



智能自动化生产线创新解决方案

Intelligent Automation Line Innovation Solution

海目星激光科技集团股份有限公司

Add: 广东省深圳市龙华区观盛五路5号科姆龙科技园B栋(总部)
广东省深圳市龙华区环观南路26号(深圳制造基地)

Tel: 0755-2803 7766 Fax: 0755-2798 5966
www.hymson.com 4006-24-365-7

海目星激光智能装备(江苏)有限公司

Add: 江苏省常州市金坛区金坛大道66号
Tel: 0519-82990888 Fax: 0519-82990988

海目星(江门)激光智能装备有限公司

Add: 广东省江门市蓬江区金桐八路18号
Tel: 0750-2633633

版本号: HMX80C2206C-2



移动端官网



海目星激光公众号

企业介绍

ENTERPRISE

Introduction

海目星激光是中国激光和自动化综合解决方案领先提供商，是集研发、制造、销售、服务于一体的国家级高新技术企业，以“改变世界装备格局，推动人类智造进步”和成为“全球领先的工业激光与自动化智造第一品牌”为其企业愿景和产业价值定位。

海目星激光总部位于深圳龙华区，现有海目星激光智能装备(江苏)有限公司、海目星(江门)激光智能装备有限公司等多家全资子公司。

产品和服务

智能自动化生产线、锂电自动化、风冷紫外激光设备、大型激光切割设备、蓝宝石切割设备、PCB打标设备等，已广泛应用于锂电，3C、钣金等智能制造产业，同时企业已具备为智慧工厂，智能装备领域提供激光及自动化专属定制化及标准化批量化解决方案的经验与能力。



海目星激光智能装备(江苏)有限公司



海目星(江门)激光智能装备有限公司



深圳制造基地

部分合作伙伴 OUR PARTENERS



智能自动化生产线创新解决方案

Intelligent Automation Line Innovation Solution

- 海目星专注3C、电源、电子变压器全流程装配工艺解决方案, 已为世界知名公司提供超过70条大型自动化装配生产线。
- 国内全自动化打标线的开拓者, 一直保持业内一流水平, 已为世界知名公司提供超过35条全自动化电源打标生产线。
- 首创国内第一条变压器自动化生产线, 改变了变压器行业传统劳动密集型现状, 目前多个客户多个项目正在开发应用中。
- 在自动化精密组装, 贴标, 焊锡, 点胶, 高速流水线等技术领域有超过90项国家发明及实用新型专利。
- 高度标准化、模块化设计、企业级标准的零件设计库, 模块设计库应用, 可快速响应客户定制化, 快速投入生产的需求。
- 为客户提供售前的技术支持, 帮助客户完善生产工艺及提供自动化生产方案。
- 完善的售后服务和驻场服务, 确保客户的生产进度及产品品质。

HONOR 荣誉展示

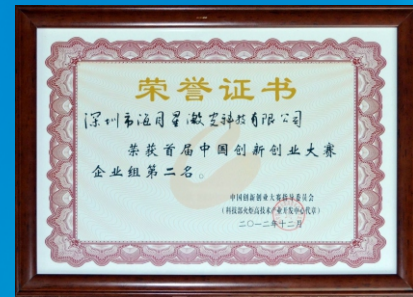

荣誉资质 ENTERPRISE Honor

海目星作为行业领先的激光及自动化综合解决方案提供商，在专业领域上获得诸多殊荣。

- 国家级高新技术企业
- 首届中国创新创业大赛企业组第二名
- 中国智慧城市Smart杯，中国智慧城市行业创新领军人才奖
- 首届中国创新创业大赛深圳赛区成长企业组第一名
- 国家“万人计划”科技创新领军人才
- 激光行业荣格技术创新奖
- 2015年度最具影响力蓝宝石行业品牌评选年度设备厂商
- 2016年度高工锂电创新产品奖
- 2016年度高工锂电最具投资价值设备企业奖
- 2017年第四届工业设计“红帆奖”技术创新奖
- 2017年度深圳市知识产权优势企业
- 2018年度特殊贡献奖
- 2018年度广东省守合同重信用企业
- 2018年龙华区工业百强企业
- 2019年中国激光行业影响力企业奖
- 2020 激光行业杰出进步企业奖
- 广东省激光行业协会副会长单位
- 广东省电源行业协会理事单位
- 2021年 CATL“年度优秀供应商”称号
- 2021年深圳先进制造业智能装备领域拓荒牛奖
- 第十九届深圳知名品牌
- 第二十三届中国专利优秀奖

科研能力

Research&Development Capacity

海目星拥有完善的研发体系，组建了三大研发中心，面向激光技术，自动化技术和锂电自动化技术，累计获得百余项国家专利，能够为客户提供全面的技术解决方案和支持。

自动化开发团队由百余名工程师组成，其中60%以上工程师具有5年以上自动化产品开发经验，具备大型装配自动化，检测自动化，测试自动化的开发能力，可同时展开5个大型自动化项目的开发工作。

同时与哈工大机械工程系，西安交大材料系开展深入合作，投入大量研发经费，面向激光焊锡技术，特定锡膏配方，激光标刻技术等新技术及产业化研究，实行开放式研究，产学研相结合，自主创新与合作创新有机结合。

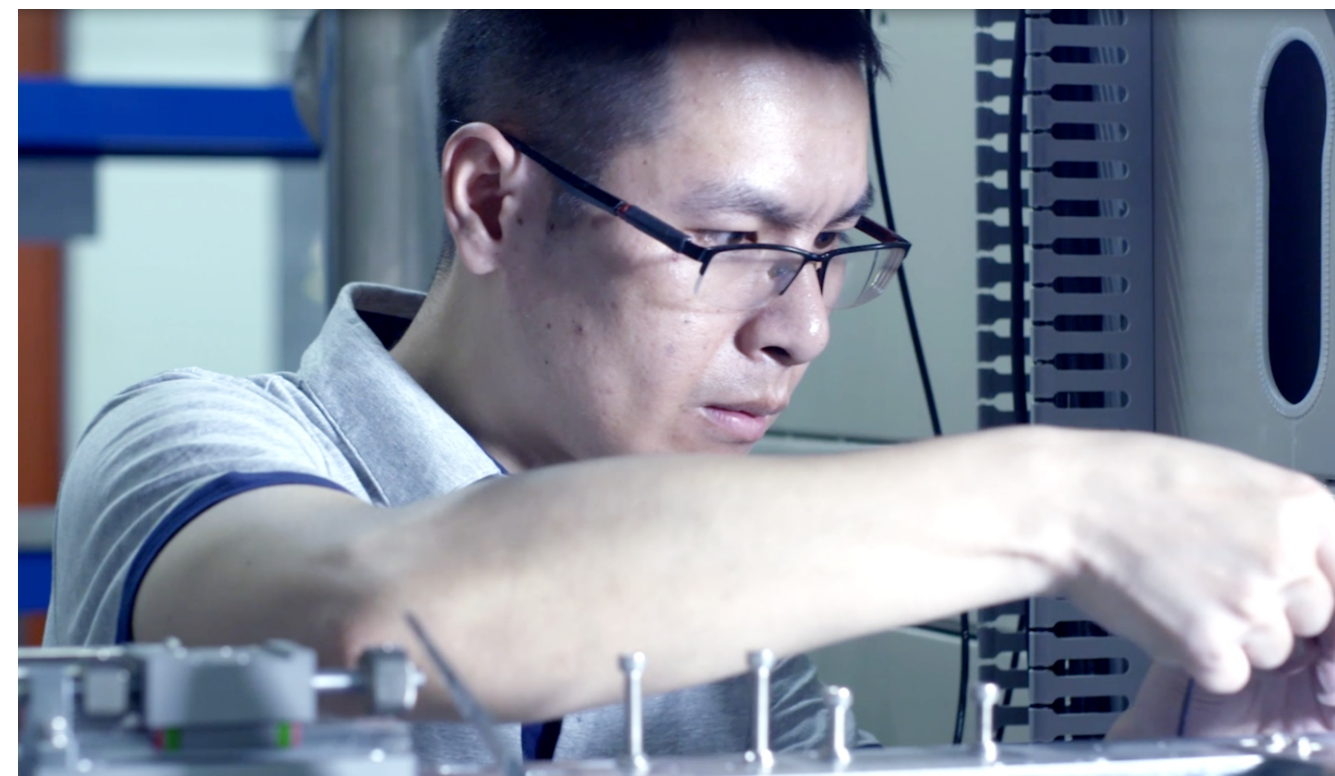

生产能力 Production Capacity

激光及自动化应用中心在深圳拥有8000平米的生产基地,全部实行封闭式保密化管理,可以满足同时进行30条大型自动化生产线的装配和调试的要求。

公司严格按照ISO9001质量管理体系和精益生产的要求,实施全过程的质量控制,以满足顾客需求为宗旨,持续改进,创新增效,永不停顿。在生产管理,创新能力及信息化管理等方面追求领先地位,具备专属定制化及标准化,批量化解决方案的经验与能力。



质量保证 Quality Assurance

秉承“产品质量和可靠性是我们生存的根本”的核心理念,建立并通过ISO9001质量管理体系,并在此基础上,引进了TQM全面质量管理概念和方法,把公司每个部门都作为品质管理的重要一环,而打造出立体的品质体系。

设计质量管控:测试、签样、定型、变更、工艺及检验方法等,使用APQP等工具,优中选优,层层把关,最终确定出最好的设计方案。

生产质量控制:通过系统完善的过程管控流程,在生产过程中贯彻、注重如Control Plan,PFMEA等质量过程管控手段,推动质量持续改善。

完善的量测体系:配备了完善及先进的测量设备,如海克斯康三坐标测量机,基恩士1000倍三维显微镜,激光聚焦光束分析仪,M2检测仪,X-RAY等一批量测仪器。

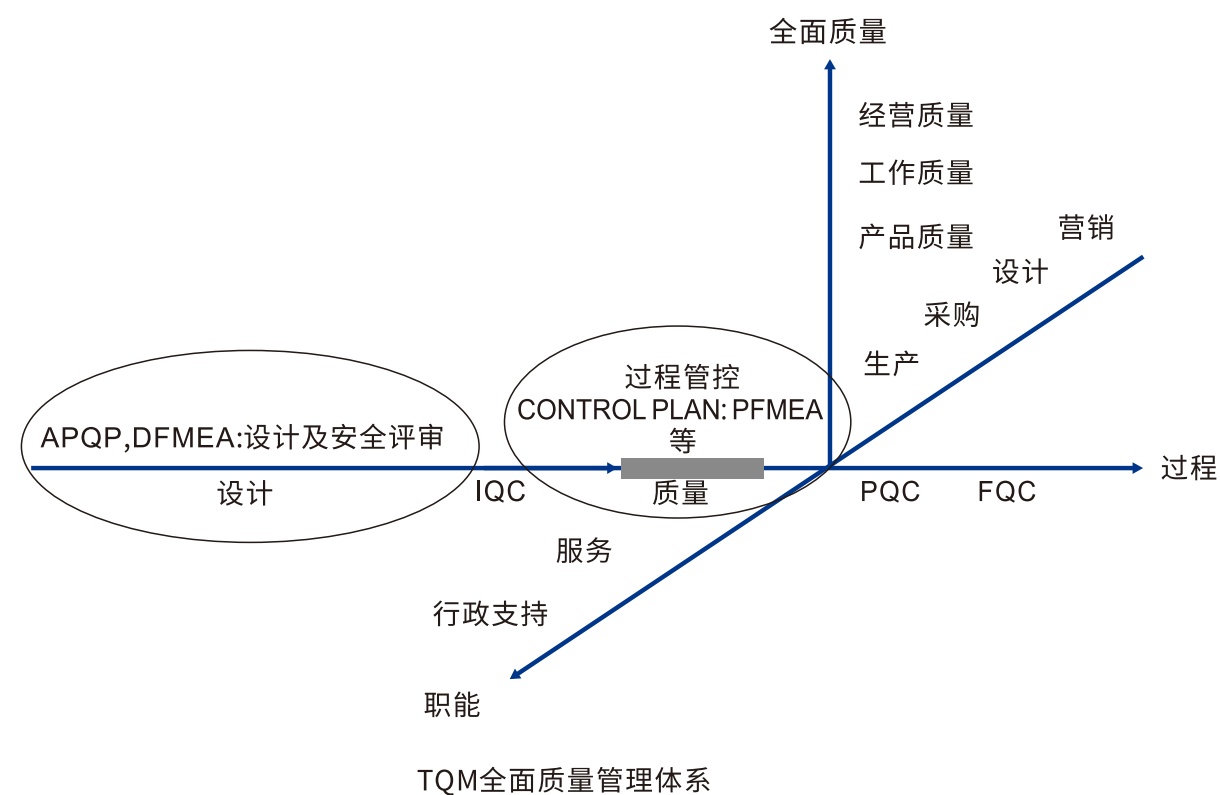

目录 Catalog

“隼”系列激光打标机模组	1
标准红外激光打标机	2
绿光激光打标机	3
双工位紫外激光打标机	4
超快激光打标机	6
全自动激光剥线机	8
精密激光表面处理解决方案	9
电源自动打标线	10
全自动PCB激光打标机	11
激光分板机	14
全自动PCB激光去除机	16
全自动IC激光打标机	18
全自动PCB覆铜板打标机	20
卷对片覆盖膜激光切割机	22
单工位激光切割成型机	24
透明脆性材料精密激光切割机	26
玻璃激光钻孔机	28
光伏玻璃打孔机	30
C系列 CW光纤激光焊接机	32
Q系列 QCW激光焊接机	34
N系列 纳秒激光焊接机	36
P系列 塑料激光焊接机	38
Q系列 双通道激光焊接模组	40
动力电池顶盖激光焊接机	42
料带激光切焊一体机	44
S系列 激光送丝焊锡机	46
J系列 激光锡球焊锡机	48
导电胶点胶机	50
高速点胶机	52
太阳能逆变器自动组装线	54
电源自动组装线	56
变压器自动组装线	58
平面变压器自动化组装线	59
PCB防水镭射除胶智能装备	60
VCM马达自动组装线	62
纽扣电池电芯组装线	64
纽扣电池PACK线	65
软包电池PACK线	66

“隼”系列激光打标机模组

“Falcon” Series Laser Marking Machine Module



“隼”系列激光打标模组采用海目星最新研发激光器, 涵盖355nm、532nm、1064nm、10640nm等波段, 可以方便集成至食品、药品、工艺品、3C、服装、医疗、航天、军工、汽车、新能源等行业自动化产线中并且提供最优激光加工工艺支持, 遍及全球的售后服务网络为客户提供7*24小时无忧服务; 体积小, 提供socket或IO通讯接口, 与上下位机实时通讯; 提供视觉定位子模块, 替代机械定位, 实现自动化激光加工。It adopts Hymson's latest R&D laser, covering 355nm, 532nm, 1064nm, 10640nm, etc. It can be easily integrated into the automation production line of food, medicine, handicraft, 3C, clothing, medical, aerospace, military, automobile, new energy, etc., And provide the best laser processing technology support, the global after-sales service network to provide customers with 7*24 hours worry-free service. Small size can be easily integrated into various automated production lines, providing socket or IO communication interface, real-time communication with the upper and lower position machine; providing visual positioning sub-module instead of mechanical positioning to realize automatic laser processing.

Equipment Feature 设备特点

- 性能稳定, 可长时间工作。
- 支持PLT、PCX、DXF、BMP等文件, 直接使用SHX、TTF字库。
- 支持工业4.0和智能制造, 打造全新生产模式。
- 体积小巧, 集成方便。
- 全封闭光路, 环境耐受力好。
- 支持自动编码、序列号、批号、日期、条形码及二维码的打标, 软件具有图形反打功能, 配备光幕装置, 使用更安全。
- Stable performance and long working hours.
- Support PLT, PCX, DXF, BMP, etc., and use SHX, TTF fonts directly.
- Support Industry 4.0 and smart manufacturing to create a new production model.
- Small size and easy integration.
- Fully enclosed light path, good environmental tolerance.
- Supports automatic coding, serial number, batch number, date, barcode and QR code marking. The software has the function of graphic reverse marking and is equipped with a light curtain device for safer use.

Parameters 产品参数

设备型号 Device Model	HP-E0AC
最大激光功率 Laser Power	3W/5W/20W/30W/50W
激光波长 Laser Wavelength	355nm/532nm/1064nm/10640nm
重复频率 Repeat Frequency	1-100KHz
雕刻线速 Marking Line Speed	≤7000mm/s
雕刻范围 Marking Range	≤300mmx≤300mm
重复精度 Repetition Accuracy	±0.003mm
冷却方式 Cooling Mode	风冷/水冷 Air Cooling/Water Cooling
电力需求 Power Demand	220V/50Hz
整机功率 Machine Power	1KW

标准红外激光打标机

Standard Infrared Laser Marking Machine

主要用于替代传统落后的制造工艺,如:丝印移印、腐蚀、模具冲压等。先进的激光加工系统可迅速提高品质与生产效率。

It mainly substitutes for the traditional manufacturing processes such as silk-screen printing and pad printing, corrosion and die stamping. Advanced laser processing system can improve the quality and efficiency rapidly.

Equipment Feature 设备特点

- 激光功率输出稳定、光斑质量好。
- 标刻速度快,是传统机型的2-3倍。
- 无任何操作系统限制,操作方便,光路全封闭,稳定可靠,免维护,超长寿命。
- 无污染、无噪音、无耗材、耗电量为传统机型的5%-10%。
- 超高精细度,分辨率达2540dpi。
- Stable laser power output and good beam spot quality.
- Fast marking speed (2-3 times faster than the traditional machines).
- Without operation system limit, convenient operation, fully enclosed light path, good stability and reliability, free of maintenance and extra-long service life.
- Free of pollution, noise and consumables, with 5%-10% power consumption of the traditional machines.
- Super-finesse, with the resolution ratio of 2540dpi.

Applications 应用

手机制造业、微电子、汽车行业、医疗器材、钟表、五金、珠宝、卫浴洁具等。

Cell phone manufacturing industry, micro-electronics, auto industry, medical instrument, clock, hardware, jewelry and sanitary ware.

Parameters 产品参数

设备型号 Device Model	HE-M15
最大激光功率 Laser Power	10W/15W/20W/30W/50W/100W
激光波长 Laser Wavelength	1064nm
光束质量 Beam Quality	$M^2 < 1.2$
重复频率 Repeat Frequency	$\leq 1000\text{KHz}$
雕刻线速 Marking Line Speed	$\leq 9000\text{mm/s}$
雕刻范围 Marking Range	100mmx100mm or 160mmx160mm
最小线宽 Minimum Line Width	0.05mm
最小字符 Minimum Character	0.1mm
冷却方式 Cooling Mode	风冷 Air cooling
电力需求 Distribution Demand	220V/50Hz
整机功率 Machine Power	1KW

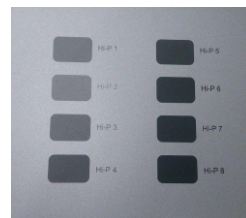

绿光激光打标机

Green Laser Marking Machine

Equipment Feature 设备特点

- 稳定的输出功率, 优越的光束质量。
- 专利谐振腔体散热设计, 散热快, 保证腔体内温度稳定。
- 灵活的激光平台设计, 可输出不同波长, 不同功率和脉冲宽度, 适应不同加工要求。
- 优化的工业配件, 免维护, 连续使用长达20000小时。
- Stable output power and superior beam quality.
- The thermal design of the patent resonant cavity is fast in heat dissipation and ensures stable temperature inside the cavity.
- The flexible laser platform design, can output different wave lengths, powers and pulse widths to meet different processing requirements.
- Optimized industrial parts are free of maintenance and can be used continuously for 20000h.

Applications 应用

广泛应用于食品、药品、化妆品、电线等高分子材料的包装瓶(盒)表面打标、打微孔(孔径 $d < 10\text{um}$)。

Be widely used for marking and micropore processing (diameter: $< 10\text{um}$) on the high polymer packaging bottle (case) for food, drugs, cosmetics and wires.

Parameters 产品参数

项目名称 Item	技术参数 Parameter
设备型号 Device Model	HF-M1AG08
激光波长 Laser Wavelength	532nm
输出功率 Output Power	$> 8\text{W}@30\text{KHz}$
脉冲宽度 Pulse Width	13-80ns
功率稳定性 Power Stability	$< \pm 2\% \text{rms}$
光束质量 Beam Quality	$M^2 < 1.3$
重复频率 Repeat Frequency	1KHz-200 KHz
光束发射角 Beam Emission Angle	$< 2\text{mrad}$
最小线宽 Minimum Line Width	0.02mm
偏振 Polarization	100:1vertical
冷却方式 Cooling Mode	风冷 Air cooling
配电需求 Distribution Demand	220V/50Hz/5A
整机功率 Machine Power	500W



双工位紫外激光打标机

Double-station UV Laser Marking Machine

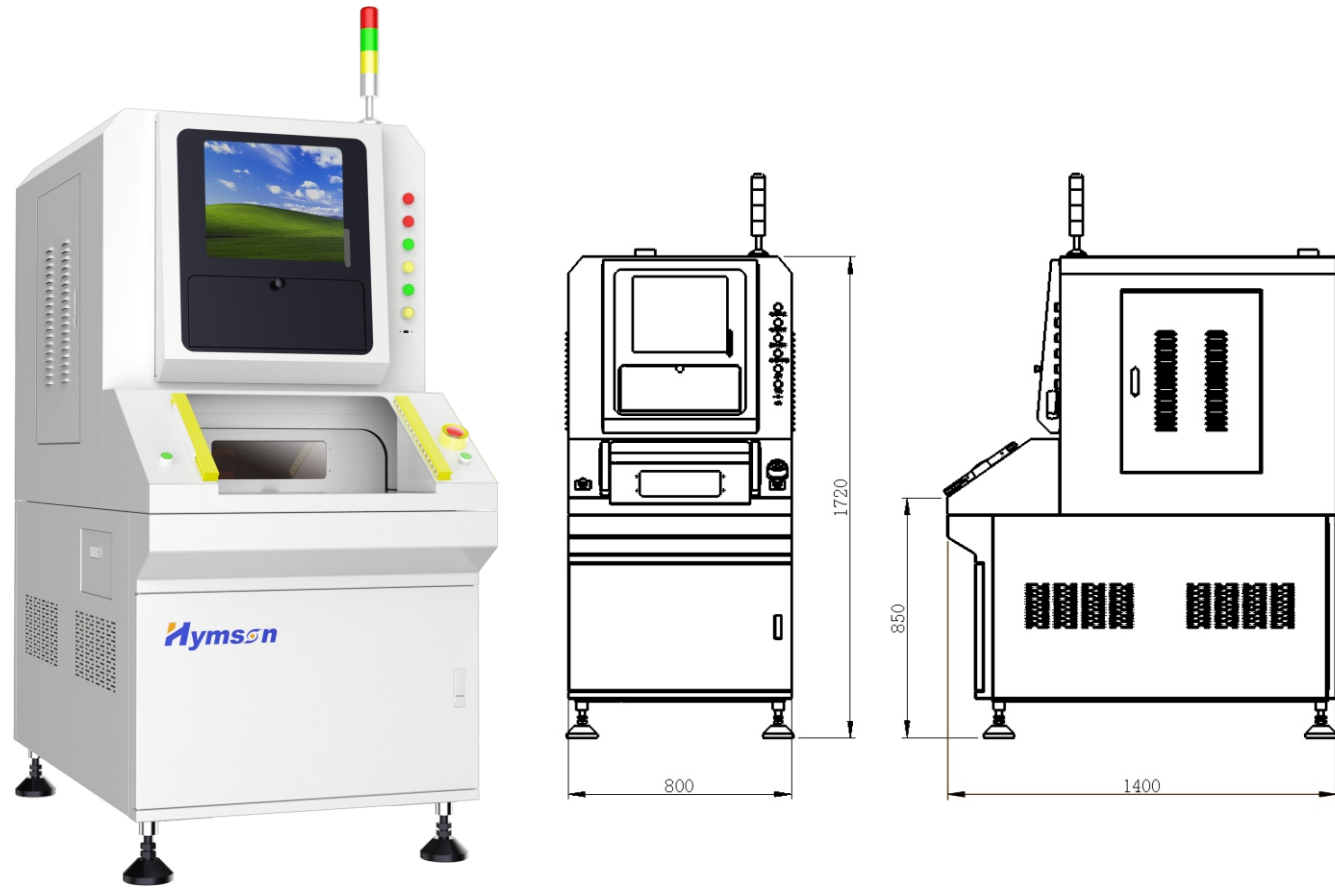

Applications 应用

- 适用于玻璃、高分子材料等物体表面打标、微孔加工。
- 广泛应用于食品、药品、化妆品、电线等高分子材料的包装瓶(盒)表面打标、打微孔(孔径 $d < 10\mu\text{m}$)。
- 柔性PCB板、LCD、TFT打标、划片切割等。
- 金属或非金属镀层去除。
- 硅晶圆片微孔、盲孔加工。
- Be applicable to marking and micropore processing such as glass and high polymer material.
- Be widely used for marking and micropore processing (diameter: $< 10\mu\text{m}$) on the high polymer packaging bottle (case) for food, drugs, cosmetics and wires.
- PCB, LCD, TFT marking and scribing cutting.
- Removal of metal or non-metal coating.
- Processing of silicon wafer micropores and blind holes.



Equipment Feature 设备特点

- 稳定的全风冷紫外激光。
- 可选择多种模式进行首脉冲抑制,达到最佳抑制效果。
- 高精度温度控制PID算法。
- 灵活的控制方式,全参数的内外控选择,适合不同客户应用的要求。
- Stable and full air-cooling UV laser.
- Multiple options for initial pulse suppression to achieve the best effect.
- High-precision temperature control, PID algorithm.
- Flexible control mode and full-parameter internal and external control to meet the different requirements from customers.

Parameters 产品参数

项目名称 Item	技术参数 Parameter
设备型号 Device Model	HT-M2AU05
激光波长 Laser Wavelength	355nm
输出功率 Output Power	5W/10W/15W
脉冲宽度 Pulse Width	13-80ns
功率稳定性 Power Stability	$< \pm 2\% \text{rms}$
光束质量 Beam Quality	$M^2 < 1.3$
重复频率 Repeat Frequency	1KHz-200 KHz
光束发射角 Beam Emission Angle	$< 2 \text{mrad}$
最小线宽 Minimum Line Width	0.01mm
偏振 Polarization	100:1vertical
冷却方式 Cooling Mode	风冷 Air cooling
配电需求 Distribution Demand	220V/50Hz/5A
整机功率 Machine Power	500W

超快激光打标机

Ultrafast Laser Marking Machine



此设备主要应用于材料表面的激光微加工处理。针对3C制造行业研发的超快激光打标机,适用于陶瓷表面精密打标,手机玻璃盖板表面标记处理、摄像头保护镜片油墨清除,PVD退镀,PCB/FPC刻槽等多种应用。设备配备超快激光器,集成了高速,高精度的光学加工系统,独立的工艺,加工路径优化系统,超快激光应用极大的改善了产品的加工品质,加工精度高、热影响区域小、加工边缘无毛刺和残渣、长期稳定性好。可以对多种材料进行精密打标、钻孔、切割及划槽等微加工处理。

This machine is mainly used for laser micro machining of material surfaces. Ultra-fast laser marking machine developed for 3C manufacturing industry, suitable for precision marking of ceramic surface, surface marking treatment of mobile glass cover, ink removal of camera protection lens, PVD deplating, PCB/FPC groove. With ultra-fast laser, integrated with high-speed, high-precision optical processing system, independent process, processing path optimization system, ultra-fast laser application greatly improves the processing quality of the product, high processing precision, small heat affected area, processing the edges are free of burrs and residues, and have good long-term stability. Micro-machining for precision marking, drilling, cutting and grooving of a wide range of materials.

Equipment Feature 设备特点

- 配备高性能红外、绿光或紫外皮秒激光,功率和脉冲宽度等可调,加工效率高,可加工多种材质的产品。
- 采用大理石底座及高精度直线电机,全闭环反馈控制,精度高,稳定性好。
- 配备高精度CCD视觉定位系统,能准确识别抓取各种标记点,保证加工位置精度。
- 专业打标软件,支持多种文档格式,性能稳定,简单易用。
- Equipped with high-performance infrared, green or ultraviolet picosecond laser, adjustable power and pulse width, high processing efficiency, and processing a variety of materials.
- It uses marble base and high-precision linear motor, full-closed feedback control, high precision and good stability.
- Equipped with high-precision CCD vision positioning system, it can accurately identify and capture various marking points to ensure the accuracy of machining position.
- Professional marking software, support a variety of document formats, stable performance, easy to use.

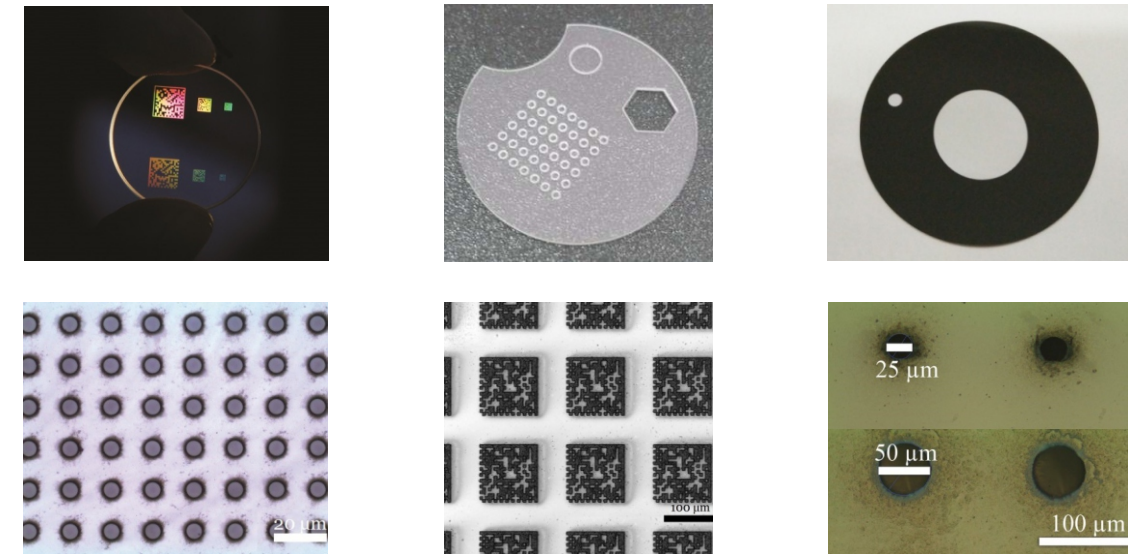

Parameters 产品参数

项目名称 Item	技术参数 Parameter
设备型号 Device Model	HP-KPL
最大激光功率 Laser Power	5W/8W/10W/15W/25W/50W
激光波长 Laser Wavelength	355nm/532nm/1064nm
重复频率 Repeat Frequency	100kHz-10000KHz
雕刻线速 Marking Line Speed	≤10000mm/s
雕刻范围 Marking Range	100 x 100mm
重复精度 Repetition Accuracy	±0.003mm
冷却方式 Type of Cooling	水冷 Water cooling
电力需求 Power Demand	220V±22V / 50Hz
整机功率 Machine Power	2.5KW

全自动激光剥线机

Full-automatic Laser Wire-stripping Machine

采用激光去除漆包线以及喷涂层的工艺取代传统工艺,传统手工刮漆皮工艺效率低,刮漆皮后导电性能不稳定。使用原装进口光纤激光器配合高速扫描振镜系统,输出功率稳定,光束质量好,效率高,加工成本低,无耗材,无接触,生产稳定等优点,能满足工业化连续工作,加工产品导电性能高、浸锡外观效果好。可通过治具更换适用于电子线材(如:极细同轴线、RF天线、电子线、0.5mm以下的细小数据线)绝缘层、屏蔽层的剥离。同时,也适用于电感线圈去漆应用,解决人工去除8个面的治具翻转问题,自动化程度高。

The technology of enameled wire removal and coating spraying with laser substitutes displaced the traditional craft which is low in efficiency and unstable in conductivity after scraping paint coat artificially. The imported fiber laser and high-velocity scanning galvanometer system has the advantages of being stable in output power, good in beam quality, high in efficiency, low in processing cost, free of consumables and contact, stable in production, able to meet the industrial continuous working requirement, high in conductivity and good in wicking appearance effect. Be applicable to the peeling of insulating layer and shielding layer of electronic wires (such as ultra-fine coaxial line, RF antenna, electron beam and fine data line less than 0.5mm) through fixture. Be applicable to the depainting of inductance coil, solve the 8-sides fixture rollover problem during artificial removal and be high in automation degree.

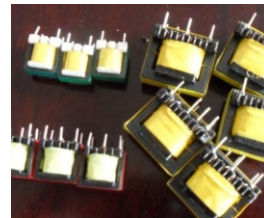
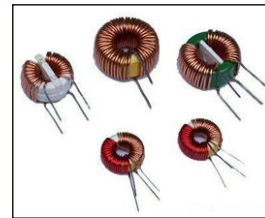
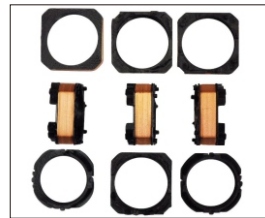

Parameters 产品参数

项目名称 Item	技术参数 Parameter
激光波长 Laser Wavelength	1064nm
激光器功率(W) Laser Power	50/100 可选 optional
送料工作台行程(mm) Moving Distance of Feeding Worktable	200 可选 optional
送料工作台速度(mm/s) Speed of Feeding Workbench	≤350
定位精度(mm) Positioning Accuracy	±0.05mm
重复定位精度(mm) Repeated Positioning Accuracy	±0.08mm
系统定位精度(mm) System Positioning Accuracy	≤ ±0.05mm

精密激光表面处理解决方案

Precision Laser Surface Treatment Solutions

传统表面处理是使用机械、碳氢、酸洗等工艺,对工件表面进行清洁、去毛刺、去油污、去氧化层等,在处理过程中使用化学溶液,产生大量废水废气,严重污染环境。

The traditional surface treatment uses mechanical, hydrocarbon, pickling and other processes to clean,debur,degrease, deoxidize the surface of the workpiece, etc., using a large amount of chemical solution in the process, generating a large amount of waste water and waste gas, seriously polluting the environment.

海目星创新的表面处理工艺则是在传统工艺的基础上进行大胆的改革,使用激光对工件表面进行清洗、清扫、去除氧化层、镀层、绝缘漆层等,并通过尖端的激光光源,配合精密的光学设计,对工件进行拉丝、镜面、炫彩、抛光等处理。

Hymson's innovative surface treatment process is based on the traditional process of bold reform,using laser to clean the surface of the workpiece, cleaning, removing oxide layer, coating, insulating lacquer layer, etc. and through the cutting-edge laser source, with Precision optical design, drawing, mirroring, brightening, polishing, etc.

激光表面处理还可用于有机涂层和金属镀层的去除,及化学复合涂层的预处理等,如油漆、油墨、阳极氧化层、绝缘层、及钛、镉等PVD、OC0镀层等;根据激光加工介入的时间点,可以分为镀前、镀中和镀后激光加工,激光的非接触式加工,瞬时高温及高能量密度,可以精确控制材料气化厚度,使表面镀层完全去除且不伤及基材。

Laser surface treatment can also be used for the removal of organic coatings and metal coatings,as well as the pretreatment of chemical composite coatings, such as paints, inks, anodized layers, insulating layers, and PVD,OC0 coatings such as titanium and cadmium; The processing time can be divided into pre-plating, in-plating and post-plating laser processing, laser non-contact processing, instantaneous high temperature and high energy density, which can precisely control the material vaporization thickness, so that the surface coating is completely removed and not damaged substrate.

Equipment Feature 设备特点

- 表面异物处理
- 阳极氧化层、电泳层、绝缘层、油漆、阻焊油墨、遮蔽油墨等材料的剥离
- 有机物的激光清洗,如油脂、溶液结晶体等
- 金属表面的拉丝、镜面、炫彩、抛光等处理
- 成型件、冲压件的毛刺、披锋、水口去除等
- Surface foreign matter treatment.
- Peeling of anodized layer, electrophoretic layer, insulating layer, paint, solder resist ink, masking ink, etc.
- Laser cleaning of organic substances such as grease, solution crystals, etc.
- Wire drawing, mirror surface, dazzling color, polishing of metal surface.
- Burr, burr and nozzle removal of forming parts and stamping parts.

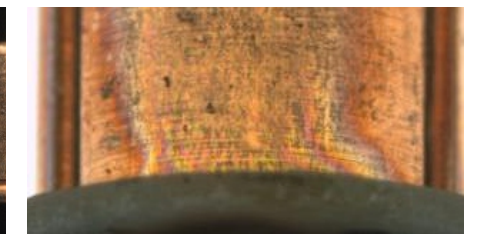
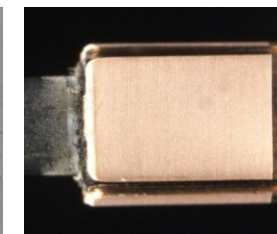
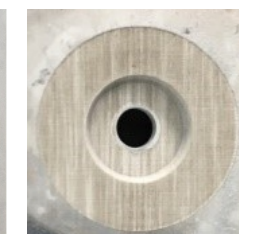

电源自动打标线

Automatic Marking Line of Power Supply



人工上下料, 自动放产品入皮带线上列队, 自动激光同步打标产品外安全标识及自动翻转打标USB内s/n号。
Artificial feeding and blanking, automatic placement of products on the belt line for ranking, automatic laser simultaneous marking of outer safe signs and automatic flip marking of s/n number in USB.

Equipment Feature 设备特点

- 国内首批电源自动雕刻机。
- 整机采用模块化设计, 便于线体拆装、定制和运输。
- 多项专利应用其中, 使该自动生产线的生产效率大大高于人工作业。
- The first power automatic engraving machine in China.
- The modular design of complete machine is convenient for line disassembly, customization and transportation.
- The production efficiency of automatic production line is much higher than artificial operation due to its various patented technologies.

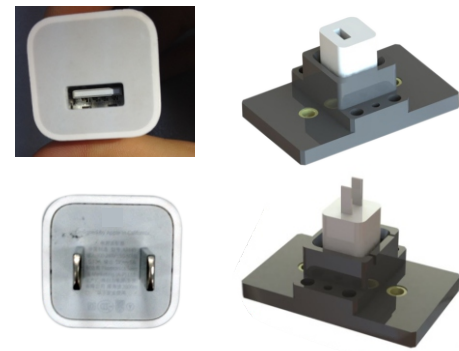

Parameters 产品参数

本设备是自动化与激光结合应用的经典案例, 1名操作员负责将新产品放入皮带流水线(也可选配全自动化上下料), 6台激光同时对6个产品进行定位雕刻; 最大限度的节省了人力, 提高了生产效率; 采用标准化模块设计, 方便工艺调整及设备升级; 实时与服务器进行数据交换, 及时对产品生产信息进行存档, 确保了产品生产信息的准确性。

描述 Description

The machine is a classic case integrating automation and laser. 1 operate is responsible for placing the new product into belt assembly line (or choose full-automatic feeding and blanking), and 6 lasers will conduct positioning engraving on 6 products simultaneously; save the manpower to the maximum and improve the production efficiency; the standard modular design is convenient for craft adjustment and machine upgrading; realize real-time data exchange with server, file the production information timely and ensure the accuracy of production information.

UPH	635PCS/H
MTBA	60Min
MTBF	168H
额定电压 Rated Voltage	AC220V
额定电流 Rated Current	20A
气压 Air Pressure	0.5MPa~0.7MPa
设备尺寸 Machine Dimension	L5200mm x W1200mm x H1800mm

全自动PCB激光打标机

Automatic PCB Laser Marking Machine

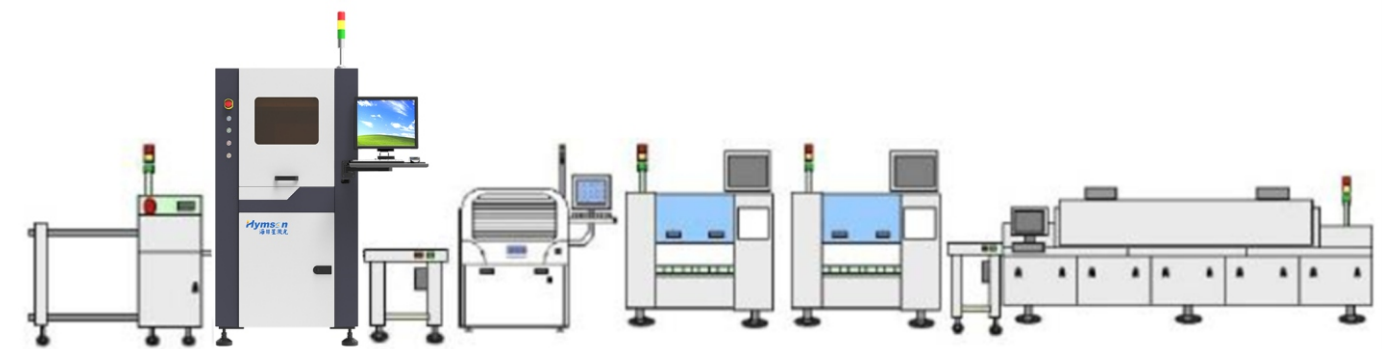

上板机 Loader PCB激光打标机 PCB Laser marking machine 印刷机 Paste printer 贴片机 Placement machine 回流焊 Reflow soldering

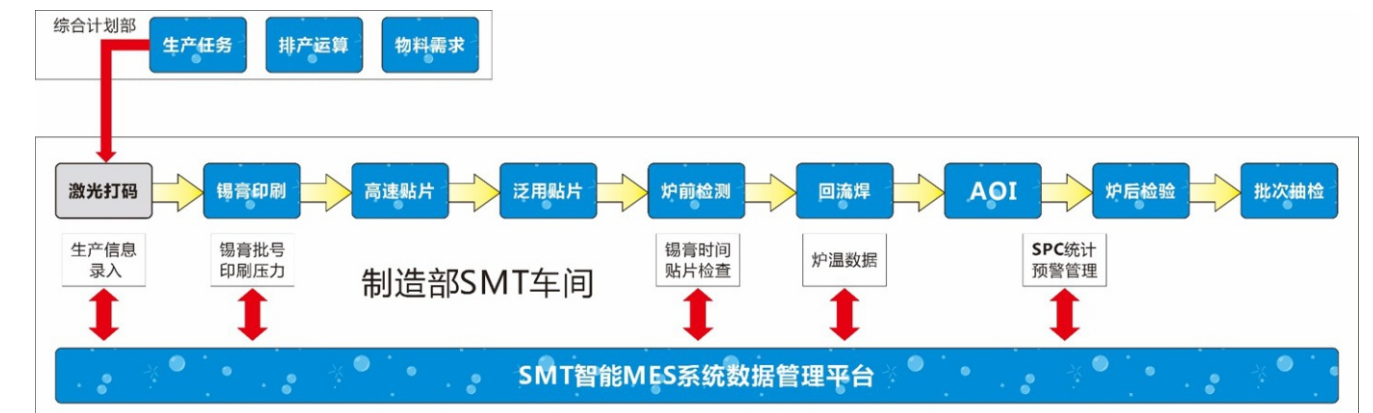

此设备用于印刷电路板上阻焊剂的直接激光标记。激光组件安装在传输系统的上方伺服驱动X/Y轴。需要标记的PCB自动传输，以固定的位置移动到目标激光雕刻区域，进行视觉定位。激光移动到一个预先设定的位置，根据不同的内容，如条码Datamatrix, QR, 一维码, 纯文本或图案标识到产品上。相机识别验证条码内容保存。

The machine is used for direct laser marking of solder resist on the printed circuit board. Laser module is installed on the transmission system, the X/Y axis is driven by servo motor. The to-be-marked PCB will transfer automatically and move to the target laser engraving area in the fixed position for visual positioning. The laser moves to a preset position and marks the content such as Datamatrix code, QR, 1D code, plain text or pattern on the product. The camera identifies the verification bar code and saves the content.

Equipment Feature 设备特点

- 可配置高性能CO₂激光、光纤激光、绿激光或紫外激光，功率和脉冲宽度等可调。
- 可配置高速X/Y运动平台或真同轴结构，可多点和矩阵运动。
- 高精度视觉定位保证打印位置精度，并在打标后确认打印内容和质量。
- 专业HMI软件，标准SMEMA接口，支持多产品文件，支持多语言及时切换，支持远程控制和数据上传等。
- With high-performance CO₂ laser, optical fiber laser, green laser or UV laser, power and pulse width adjustable.
- With high-speed X/Y motion stage or true coaxial structure, can realize multipoint and matrix motion.
- The high-precision visual positioning system ensures the marking position accuracy and confirms the marking content and quality.
- With professional HMI software and standard SMEMA interface, support multi-product file, timely switching of multiple languages, remote control and data upload.

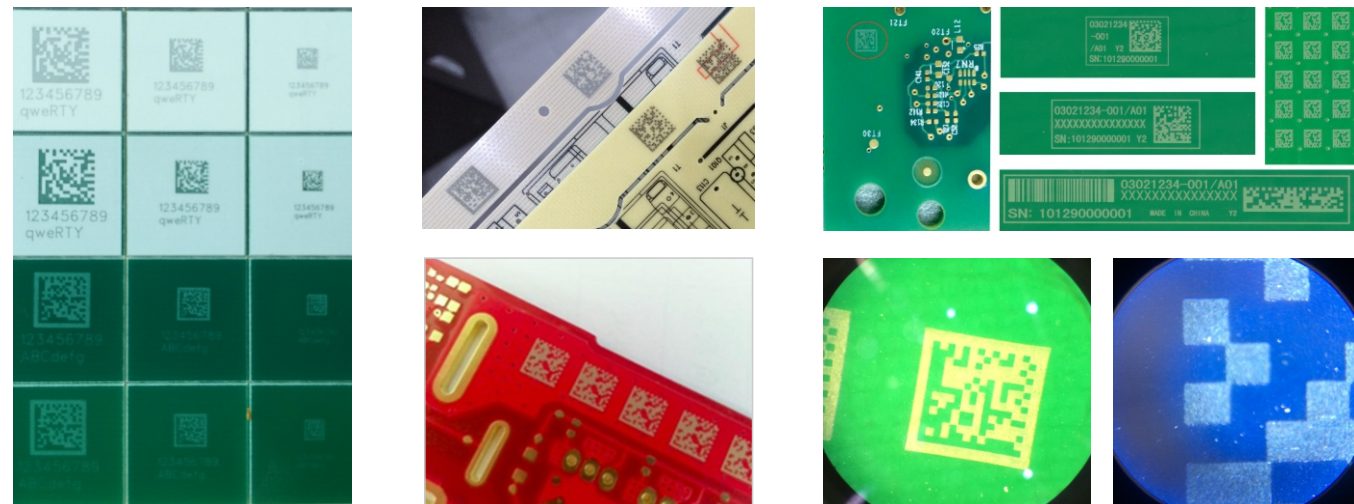

Parameters 产品参数

型号 Model	P3	P4	P6	P7
PCB 尺寸 (mm) PCB Size	350 x 280	350 x 350	510 x 460	350 x 350
打标面 Marking Area	单面 One Side	单轨翻转式 (正反两面) Slide flip mode (Front and Back)	单轨翻转式 (大幅面正反面) Slide flip mode (front and back with large range)	上下双头 (高效率) Double laser heads (high efficiency)

Parameters 产品参数

PCB厚度 (mm) PCB Thickness	0.5mm-4mm			
PCB元件高度 Height of PCB Element	上 / top 25mm		下 / bottom 25mm	
PCB翘曲程度 PCB Bending Degree	小于1mm的弯曲是可接受的 Bend less than 1mm is acceptable			
轨道高度 Slide Height	920±20mm			
摄像头 Camera	500万像素CCD相机 5 Mega-pixel CDD camera			
激光类型 Laser Type	二氧化碳/光纤/绿光/紫外 (CO ₂ /Fiber/Green/UV)			
激光波长 Laser Wavelength	10640nm/1064nm/532nm/355nm			
重复精度 Repeatability	±0.05mm			
二维码制式 Two-dimensional Code	QR, mini QR, Data matrix GS1, Data matrix			
一维码制式 One Dimensional Code	CODE39, CODE128, ITF, NW-7, EAN(JAN)/UPC RSS-14 RSS Limited, RSS Expanded			
光学镜头 Optical Lens	定焦光学镜头 Fixed-focus ptical lens			
光源 Light Source	R环形积分光源 Annular integrating light source			
X,Y平台重复定位精度 Repeated Positioning Accuracy of X and Y Platform	±0.05mm			
X,Y平台移动速度 Moving Speed of X/Y Platform	最大900mm/s (maximum)			
进出板类型 Type of Loading and Unloading	进出双向自由切换 Free two-way switching: R→L or L→R			
PCB夹持 PCB Clamp	自动夹持, 可根据需要定制各种夹持治具 Able to clamp automatically and customize various clamping and fixture as needed			
设备主体结构 Structure of Machine	高精密机械加工件 High-precision Machining Parts			
驱动 Drive	交流伺服电机 AC Servo Motor			
能耗 Energy Consumption	1.8KVA MAX	1.8KVA MAX	2.5KVA MAX	2.4KVA MAX
气压 Air Pressure	0.4-0.6MPa, 5L/min			
吸尘系统 Dedusting System	烟尘净化器 Dust purifier			
接口方式 Interface Mode	SMEMA			
设备外观尺寸 (mm) Machine Dimension (LxWxH)	1500x850x1650	1470x600x1600	1650x1000x1650	1500x750x1650
设备重量 Machine Weight	580±10kg	450±10kg	850±10kg	650±10kg
检测算法 Detection Algorithm	特徵矢量分析法 Minute-vector analysis method			
条码读取 Bar Code Reading	相机读取条码 1D/2D Bar code reading by camera 1D/2D			
条码等级检测 Bar Code Level Detection	ISO国际标准或客户指定 ISO international standard or designated by customer			
标记功能 Marking Function	整板Mark, 拼版Mark, 坏板Mark等 Whole board Mark, jointed board mark and damaged board mark			
服务器连接 Server Connection	服务器连接 Server Connection			
记录功能 Recording Function	自动生成分析 (SPC) 及数据报表 Automatic generation analysis (SPC) and data report			

激光分板机

PCB/FPC Laser Cutting Machine

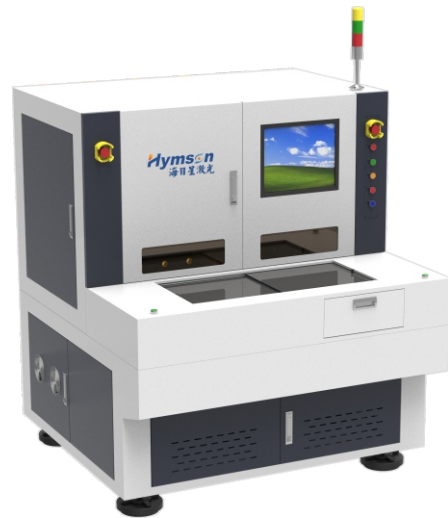

离线双工位激光分板机
Off line Dual -station PCB / FPC Laser Cutting Machine



全自动激光分板机
Automatic PCB / FPC Laser Cutting Machine

本设备主要针对线路板行业FPC软板切割、钻孔和PCB电路板分板、指纹识别芯片切割等加工进行设计开发。利用精密激光快速的切割、钻孔、打标等加工应用。在FPC软板、PCB软硬结合板等线路板材料以及PI膜、PET膜等膜片材料加工上得到广泛使用；本机型切割速度快、双工位结构大大提升产品加工效率，且具有高精度、低成本等显著优势，市场竞争力突出；全自动激光分板机对接SMT整线分板，全程机械手下料摆盘，无需人工上下料，节约人工成本。

This machine is mainly designed and developed for FPC cutting, drilling, PCB cutting, fingerprint identification chip cutting and other processing in the circuit board industry. Fast cutting, drilling, marking and other processing applications by using precision laser. It is widely used in the processing of circuit board materials such as FPC , PCB soft and hard combination board and diaphragm materials such as PI film and PET film. This machine has high cutting speed and dual-station structure, which greatly improves efficiency, and has significant advantages such as high precision and low cost, with outstanding market competitiveness. The full-automatic FPC/PCB laser cutting machine is connected to the SMT whole line for FPC/PCB cutting, and loading & unloading by manipulator, so as to save labor cost.

Equipment Feature 设备特点

- 无应力切割，避免材料应力造成产品损伤。
- 无粉尘，对环境污染小。
- 切割表面断面光滑整齐无毛刺，无碳化。
- 设备换型快，切割程序另存格式后后续可直接调用，无需更改任何参数。
- 软件可以切割任意不规则图形，如圆弧、倒角、多边形、椭圆等。
- Stress free cutting to avoid product damage caused by material stress.
- No dust and almost no environmental pollution.
- The section of the cutting surface shall be smooth, without burr and carbonization.
- The machine can be fast changeover. After the cutting program is saved, it can be called directly anytime without changing any parameters.
- The software can be set to cut any irregular figure, such as arc, chamfer, polygon, ellipse, etc.

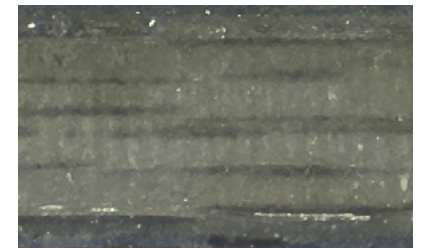
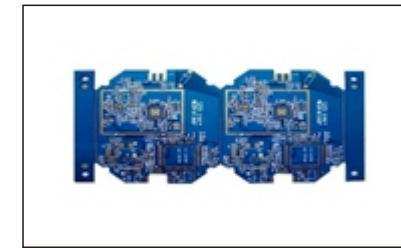
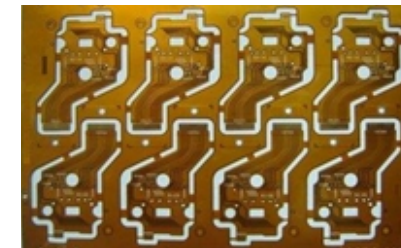
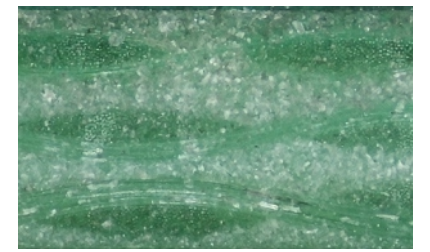
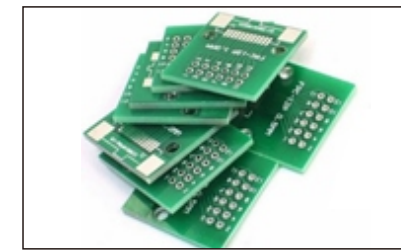

Parameters 产品参数

项目名称 Item	技术参数 Parameter		
设备型号 Device Model	单/双工位激光分板机 Single/Dual-station PCB/FPC Laser Cutting Machine	在线激光分板机 On-line PCB/FPC Laser Cutting Machine	全自动激光分板机 Automatic PCB/FPC Laser Cutting Machine
PCB厚度 PAB Thickness	≤1.5mm		
摄像头 CCD	500万像素CDD相机 5 Megapixel		
定位方式 Positioning Method	视觉定位系统 CCD		
激光类型 Laser Type	绿光/紫外 Green/UV		
激光波长 Laser Wave Length	532nm/355nm		
扫描振镜 Scanning Galvanometer	高速振镜 High Speed Galvanometer		
扫描范围 Scanning Range	50mm x 50mm		
激光加工速度 Laser Processing Speed	0~7000mm/sec		
加工平台 Processing Platform	单/双平台 Single/ Dual-Station	在线式轨道 On-line	单/双平台 Single/ Dual-Station
X/Y重复精度 X/Y Repetition Accuracy	±1um		
X/Y定位精度 X/Y Positioning Accuracy	±3um		
最大加工范围 Max Processing Range	350mm x 350mm	280mm x 300mm	280mm x 300mm (可根据实际产品设计 It can be designed according to actual products)
设备外观尺寸 Dimention	W1360mm x D1450mm x H1650mm (不含三色灯 Beacon lamp not included)		

全自动PCB激光去除机

Automatic PCB Laser Removal Machine



在线式全自动PCB激光去除设备主要用于SMT线上PCB产品材料表面UV胶和防水膜的去。其原理为激光束通过聚焦照射到材料表面,使材料表面发生物理或化学变化,在不伤产品本体的前提下达到去除UV胶和防水膜的目的。

On-line automatic PCB laser removal machine is mainly used to remove UV glue and waterproof film on the surface of PCB products on SMT line. Its principle is that the laser beam irradiates the material surface, so as to make the material surface change physically or chemically, and achieve the purpose of removing UV glue and waterproof film without damaging the product.

Equipment Feature 设备特点

- 配置高性能CO₂激光器与UV皮秒激光器,功率和频率可调。
- 专业激光控制软件,支持多文档文件,多语言随时切换,支持远程控制和数据上传等。
- 采用大理石精密平台搭配光学尺全闭环驱动加工平台,易维护,搭配高精度相机,定位精准,去除精度高。
- 专业HMI软件,标准SMEMA接口,支持多产品文件,支持多语言及时切换,支持远程控制和数据上传等。
- Equipped with high-performance CO₂ laser and UV picosecond laser, the laser power and frequency are adjustable.
- Professional laser control software, support multi-document files, multi-language switching at any time, support remote control and data upload, etc.
- Marble precision platform and optical ruler fully closed-loop driving processing platform are adopted, which is easy to maintain. With high-pixel camera, it has accurate positioning and high removal accuracy.
- Professional HMI Software, standard SMEMA interface, support multi-product files, support multi-language switching at any time, support remote control and data upload, etc.

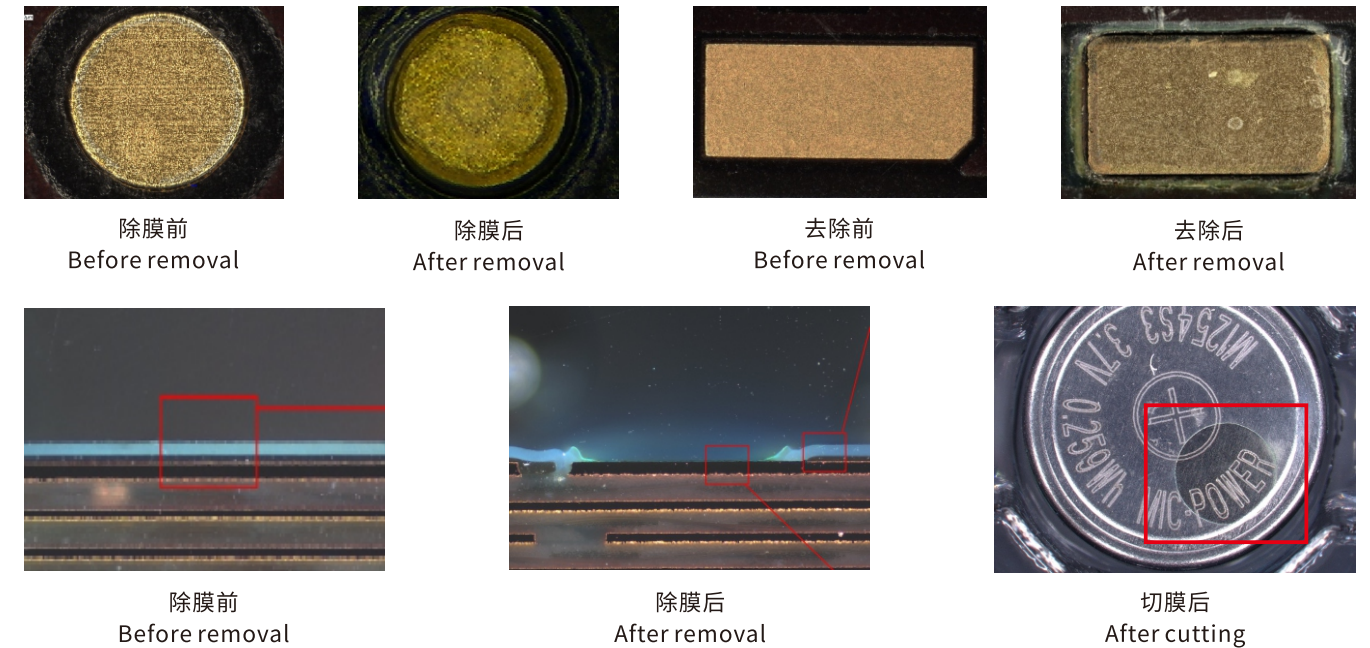

Parameters 产品参数

项目名称 Item	技术参数 Parameter	
设备型号 Device Model	HYM-C350	
PCB尺寸 PCB Dimention	50 x 50mm-280 x 350mm	
PCB厚度 PAB Thickness	0.5mm-6mm	
PCB翘曲程度 PCB Bent	小于1mm的弯曲是可接受的 Less than 1mm is Acceptable	
轨道高度 Conveyor Height	920±20mm	
激光类型 Laser Type	CO ₂ 激光、UV(CO ₂ 、UV Laser)	
激光波长 Laser Wave Length	10.6 μm	355nm
雕刻范围 Marking Area	50mm×50mm convertible	
重复精度 Repeatability	±0.025mm	
激光加工面 Laser Processing	单面 One side	
运动模组 Motion Blur	直线电机搭配光学尺全闭环驱动 Linear motor with optical ruler full closed loop drive	
设备外观尺寸 Dimention	W880mm x D1700mm x H1840mm	

全自动IC激光打标机

Automatic IC Laser Machine



在线式全自动IC、基板打标设备主要用在芯片表面材料,如金属、陶瓷、塑料封装、环氧树脂聚合物等,在不损伤元器件的前提下,标记出清晰的字符、图案、二维码等。

On line automatic IC and substrate marking equipment is mainly used for chip surface materials, such as metal, ceramic, plastic packaging, epoxy resin polymer, etc. on the premise of not damaging components, it can mark clear characters, patterns, two-dimensional codes, etc.

Equipment Feature 设备特点

- 采用弹夹或堆叠式自动上下料方式,节省上下料时间。上料和标记可单独执行,大大提高生产效率。
- 采用高速数字振镜,速度快、精度高、稳定性强。最小能支持单个字高0.15mm的字符打标需求。
- 采用高精度CCD视觉定位系统保证打标位置精度,支持识别物料进料状态与方向的功能,并在打标后确认打印内容和质量等级。
- 标准SMEMA接口及网络通信功能,可与上、下游设备及服务器进行通讯,支持远程控制和数据上传等。
- The automatic loading and unloading mode of cartridge clip or stack-based is adopted to save time. Feeding and marking can be carried out separately, which greatly improves the production efficiency.
- High speed digital galvanometer is adopted, which has high speed, accurate precision and good stability. It can support the character marking requirements with a single word height of 0.15mm.
- High precision CCD visual positioning system is adopted to ensure the accuracy of marking position, identifying the feeding state and direction of materials. And confirming the marking content and quality grade after marking.
- Standard SMEMA interface and network communication function, which can communicate with upstream and downstream equipment and servers, and support remote control and data upload.

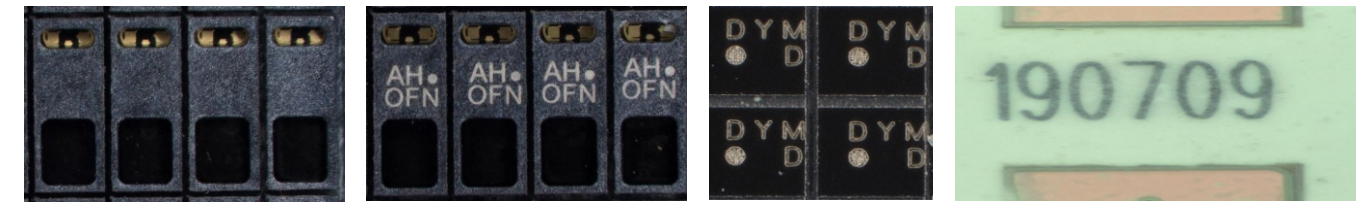

树脂打标前
Before resin marking

树脂(字高0.15mm)
Resin(character height:0.15mm)

陶瓷(字高0.1mm)
Ceramic(character height:0.1mm)



树脂打标效果(光纤、绿光、UV)
After resin marking (fiber laser, green light, UV)

IC铜基板打标,用于生产过程中信息追溯
IC copper substrate marking is used for information tracing in the production process

Parameters 产品参数

项目名称 Item	技术参数 Parameter
设备型号 Device Model	HYM-IC-300
IC尺寸 IC Dimention	50 x 50mm-150 x 300mm
IC厚度 IC Thickness	0.5mm-6mm
IC封装形式 IC Packaging Form	常见DIP、SOP、SSOP、QFM、BGA等封装形式的料条 DIP、SOP、SSOP、QFM、BGA etc.
激光类型 Laser Type	光纤/紫外/绿光 Fiber / UV / GR
激光波长 Laser Wave Length	1064nm / 355nm / 532nm
雕刻范围 Marking Area	150mm x 300mm convertible
重复精度 Repeatability	±0.02mm
字符识别 Character Recognition OCR	三色光源 1000-2000万像素 CDD相机 10-20 megapixel CDD camera with three color light source
进出板类型 Entry and Exit Type	Defined Mode:R→L
上下料 Loader/Unloader	弹夹式上下料 Slot Magaziine to Slot Magazine 堆叠式上下料 Stack Magazine to Stack Magazine
设备外观尺寸 Dimention	W2600mm x D1370mm x H1700mm

全自动PCB覆铜板打标机

Automatic PCB CCL Marking Machine



在线式PCB覆铜板和FPC铜箔打标设备主要用在单面铜箔、双面及多层覆铜基板，FPCB软硬结合板等，利用激光在材料的指定位置雕刻字符、一维码、二维码（用于生产过程中信息追溯）、通孔、盲孔、符号或图形的专业设备。
 On line PCB copper clad plate and FPC copper foil marking machine are mainly used in single-sided copper foil, doublesided and multi-layer copper clad substrate, FPCB rigid flex board, etc. characters, 1D code and 2D code are engraved at the designated position of the material by laser (for information tracing in the production process) Professional machine for through holes, blind holes, symbols or graphics.

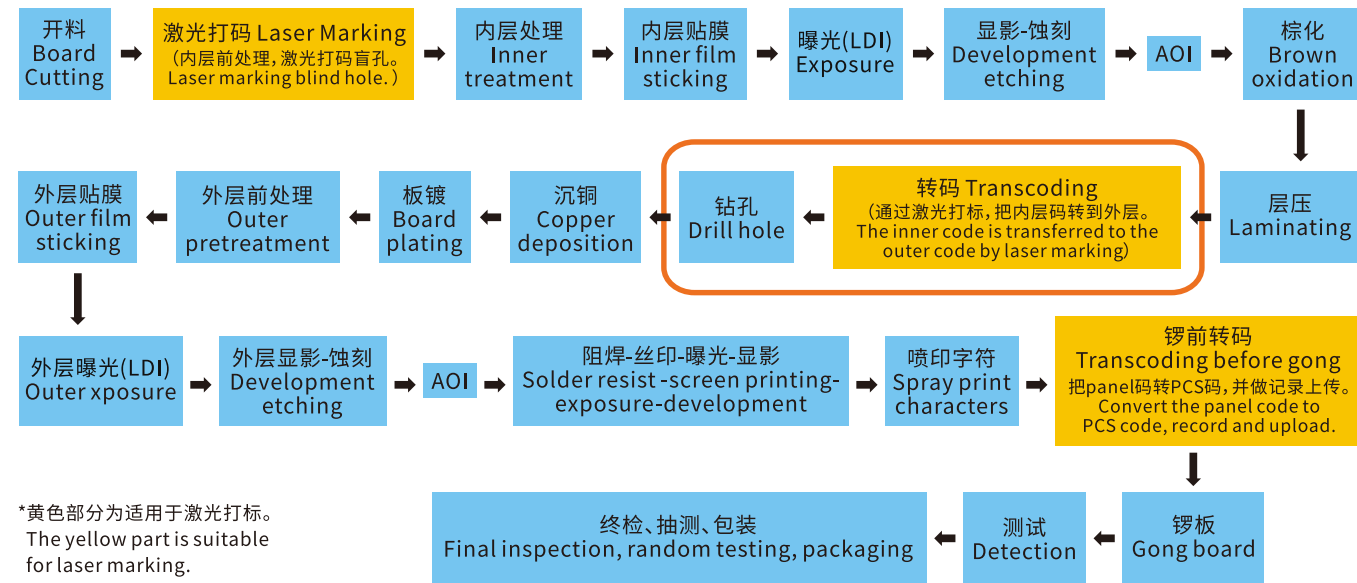

*黄色部分为适用于激光打标。
The yellow part is suitable for laser marking.

Equipment Feature 设备特点

- 高精度CCD视觉定位，可自动进行偏移补偿，设备集激光打标CCD读码一体，生产效率高。
- 标准SMEMA接口及网络通信功能，可与上、下游设备及服务器进行通讯。
- 专业激光控制软件，支持多文档格式，多种语言可随时切换，支持远程控制和数据上传等。
- 支持MES，无人化，数字化车间系统对接。
- High precision CCD visual positioning can automatically compensate the offset. The machine integrates laser marking and CCD code reading, with high production efficiency.

- Standard SMEMA interface and network communication function, which can communicate with upstream and downstream machine and servers.
- Professional laser control software, supporting multiple document formats, multiple languages can be switched at any time, supporting remote control and data upload.
- Support MES, unmanned and digital workshop system.



盲孔DM码，深度20μm
Blind hole, DM code, 3D, depth 20μm



通孔0.15孔径，DM码
Through hole 0.15 the aperture, DM code

盲孔与通孔、X-Ray扫码效果
Blind hole and through hole, X-Ray scanning effect

盲孔、DM码、3D深度20μm
Blind hole DM code, 3D depth 20μm

Parameters 产品参数

项目名称 Item	技术参数 Parameter	
设备型号 Device Model	HYM-L2A	
PCB尺寸 Dimention	Min:300mm x 300mm	Max:650mm x 750mm
PCB厚度 Thickness	0.5mm-6mm	
轨道高度 Conveyor Height	1100±20mm	
激光类型 Laser Type	光纤/紫外/绿光 Fiber / UV / GR	
激光波长 Laser Wave Length	1064nm、355nm、532nm	
雕刻范围 Marking Area	100mm x 100mm convertible	
重复精度 Repeatability	±0.5mm	
进出板类型 Entry And Exit PCBA Type	可定制 Defined Mode R→L or L→R	
设备外观尺寸 Dimention	L1200mm x W1400mm x H1700mm	

卷对片覆盖膜激光切割机

RTS Covering Film Laser Cutting Machine



卷对片覆盖膜激光切割设备主要用在FPC制程上,根据切割资料利用激光在覆盖膜材料的指定位置切出相应的图形,膜切透,离型纸不切透,也可以用于FPC成型。

The laser cutting machine for RTS covering film is mainly used in the FPC process. From the cutting data, the laser is used to cut the corresponding graphics at the specified position of the covering film material. The film is cut through and the release paper is not cut through. It can also be used for FPC forming.

Equipment Feature 设备特点

- 设备有智能分光装置(1台激光器),双头同步加工,可以单独调整各平台的工作功率。
- 设备XY轴采用双驱直线电机龙门结构,大理石基座,真空吸附平台。
- CCD视觉预扫描和自动抓靶定位,支持多种视觉定位特征,如十字、实心圆、空心圆、L型直角边等。
- 专业激光控制软件,具有自动涨缩补偿,自动计算产能、自动计算裁剪长度,一次性可以导入多个资料等功能。
- 分光双头飞行同步加工系统、功率监测系统,具有生产效率高、稳定、切割精度高等效果。
- With intelligent spectroscopic device (1 laser), double-head synchronous processing, and the working power of each platform can be adjusted independently.
- XY axis adopts double-drive linear motor gantry structure, marble base, vacuum adsorption platform.
- CCD visual pre scanning & automatic target grasping and positioning, supporting a variety of visual positioning features, such as cross, solid circle, hollow circle, L-shaped right angle edge, etc.
- Professional laser control software, with automatic expansion and contraction compensation, automatic calculation of production capacity, automatic calculation of cutting length, and multiple data can be imported at one time.
- Spectroscopic double head flight synchronous processing system and power monitoring system, high production efficiency, stability and high cutting accuracy.

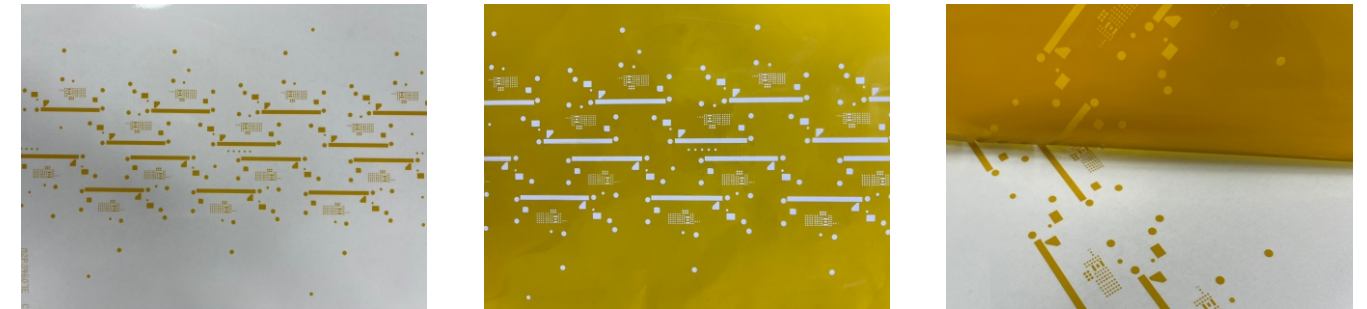

Parameters 产品参数

项目名称 Item	技术参数 Parameter
设备型号 Device Model	HP-F300S
尺寸 Dimention	300mm x 500mm
厚度 Thickness	<1mm
激光类型 Laser Type	紫外皮秒,进口或国产 UV picosecond, Imported or domestic
激光波长 Laser Wave Length	355nm
激光功率 Laser Power	30W
扫描范围 Scanning Range	50mm x 50mm convertible
激光加工速度 Laser Machining Speed	0-3000mm/sec
加工平台 Processing Platform	双平台 Double Platform
最大加工范围 Maximum Machining Range	300mm x 500mm
直线电机 Linear Motor	定位精度±0.003mm High-precision
设备外观尺寸 Dimention	L2320mm x W1400mm x H1830mm (不含三色灯 Beacon lamp not included)

单工位激光切割成型机

Single Station Laser Cutting And Forming Machine



Equipment Feature 设备特点

- 软件自动判断Mark点位置, 自动定位图档原点。
- 采用振镜扫描加工方式, 可设置振镜自动校正功能, 有效保证切割精度。
- 采用CCD精确定位, 大视野捕捉范围。
- 专业HMI软件, 标准接口, 支持多产品文件, 支持多语言及时切换, 支持远程控制和数据上传等。
- The software automatically judges the position of mark point and automatically locates the origin of drawing file.
- The galvanometer scanning processing mode is adopted, and the galvanometer automatic correction function can be set to effectively ensure the cutting accuracy
- Precise positioning with CCD, large field of view capture range
- Professional HMI software, standard interface, support for multi-product files, support for timely switching of multiple languages, support for remote control and data upload, etc.

Applications 应用

适用于覆盖膜 (CVL)、柔性板 (FPC)、软硬结合板 (RF) 和薄多层板的切割成形, 以及开窗和开盖等。

It is applicable to the cutting and forming of covering film (CVL), flexible plate (FPC), rigid flex (RF) and thin multi-layer plate, solder mask opening and cover opening.



外形切割
Shape cutting

Parameters 产品参数

项目名称 Item	技术参数 Parameter
设备型号 Device Model	HYM-C650
PCB、FPC尺寸 PCB、FPC Dimention	650mm × 550mm
PCB厚度 PCB Thickness	<2mm
摄像头 Cameras	500万像素 CDD相机 5Mega Pixel CDD Camera
激光类型 Laser Type	紫外皮秒、纳秒, 进口或国产 UV picosecond, UV nanosecond, Imported or domestic
激光波长 Laser Wave Length	355nm
激光功率 Laser Power	纳秒 Nanosecond (15W、20W) 皮秒 Picosecond (15W、30W)
扫描范围 Scanning Range	50mm x 50mm convertible
激光加工速度 Laser Machining Speed	0-3000mm/sec
最大加工范围 Maximum Machining Range	550mm x 650mm
直线电机 Linear Motor	定位精度±0.003mm High-precision
设备外观尺寸 Dimention	L1711mm x W1450mm x H1715mm (不含三色灯 Excluding tricolor lamp), 不同的平台大小尺寸有变化, 以实际为准。 Different platforms have different sizes, subject to the actual.

透明脆性材料精密激光切割机

Precision Laser Cutting Machine For Transparent Brittle



针对透明脆性材料而研发的切割设备，由皮秒激光切割、裂片模组、自动上下料组成。皮秒激光器光束经过激光成丝切割头聚焦在材料上穿孔，配合X/Y高速平台以最高可达300mm/s的速度移动，形成所需的切割线，然后利用CO₂激光/机械模组对切割线进行裂片，裂片后产品崩边<5μm，且强度更高，特别适合在蓝宝石、强化或非强化玻璃等透明脆性材料上的切割。

The cutting machine which developed for transparent brittle materials made up with pico-second laser, splitting module and automatic load/unload. Through a waveguide filament cutting head, the pico-second laser beam focus on material and perforate it, and then moves with X/Y high-speed platform at a speed up to 300 mm/s to form the desired cutting path. Then, the cutting path is splitted by CO₂ laser / mechanical module, and the edge chipping of product < 5μm, and the strength is higher. Especially suitable for sapphire, reinforced or non-reinforced glass and other transparent brittle materials cutting.

Equipment Feature 设备特点

- 采用大理石精密平台，稳定承载，耐腐蚀。
- 使用直线电机搭配光学尺全闭环驱动加工平台，易维护、精度高。
- 红外皮秒激光器，加工热影响区域小，特别适合于精细切割。
- 采用进口真空发生元件，保证产品吸附定位稳定性。
- 配置自动聚焦对位CCD及视觉镜头，能精确识别各类Mark点。
- 切割速度高达200mm/s、极小的崩边，加工效率高，产品强度高。
- 配置全自动上下料结构，减少人工操作，大幅提高产能和质量。
- Adopt marble precise platform, stable load bearing, corrosion resistance.
- Use linear motor with optical ruler full closed loop drive machining platform, easy maintenance, high precision.
- Infrared pico-second laser, small processing heat affected area, especially suitable for fine cutting.
- The imported vacuum generating element ensures the stability of product adsorption and positioning.
- Equipped with automatic focusing CCD and visual lens, it can accurately identify all kinds of Mark points.
- Cutting speed up to 200mm/s, minimal edge chipping, fast processing efficiency, high product strength.
- Automatic loading and unloading structure, reduce manual operation, greatly improve productivity and quality.

Applications 应用

- 摄像头模组保护窗、滤光片、透镜等的切割。
- 强化、非强化玻璃摄像头保护窗及盖板的切割。
- 其它透明脆性材料的切割、挖孔。
- Camera module protection window, optical filter, lens etc., cutting.
- Reinforced / non-reinforced glass camera protection window and cover cutting.
- Other transparent brittle materials cutting, perforation.

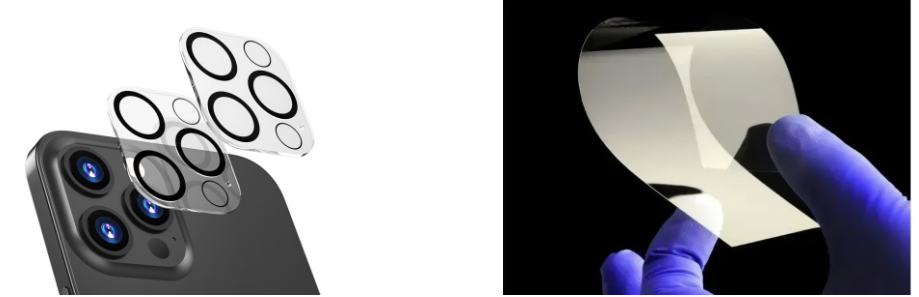
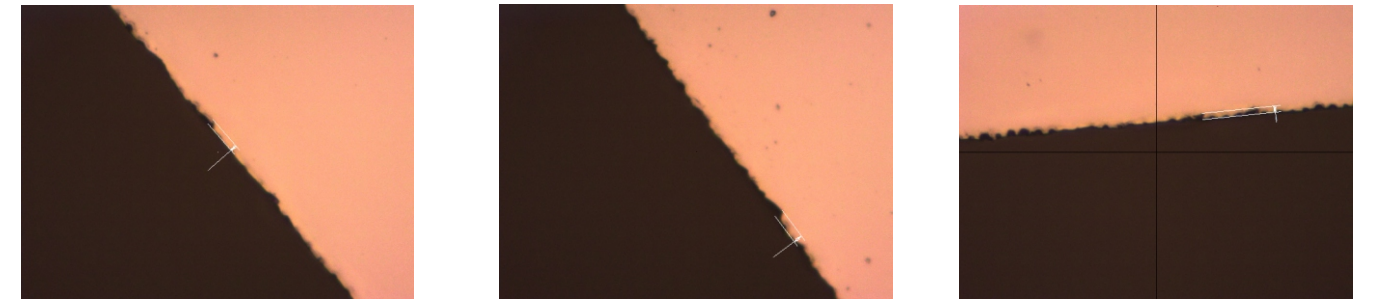

Parameters 产品参数

项目名称 Item	技术参数 Parameter
设备型号 Device Model	HP-NC050
激光器功率 Laser Power	20/30/50W
激光波长 Laser Wavelength	1064 nm
脉冲频率 Pulse Frequency	100-1000KHz
脉冲宽度 Pulse Width	≤10ps
光束质量 Beam Quality	M ² <1.3
冷却方式 Cooling Mode	水冷 Water Cooling
切割范围 Cutting Range	最大(Max) 520mm x 520mm
切割速度 Cuting Speed	0-300mm/s可调 Adjustable
切割厚度 Cutting Thickness	≤ 3mm(可定制 Customization optional)
切割最小崩边 Minimum Cutting Edge Breakage	≤ 5μm@0.5mm, ≤10um@2mm, ≤20um@3mm 以光面非强化玻璃为基准 Smooth non-reinforced glass as the benchmark
X/Y移动速度 X/Y Moving Speed	≤600mm/s
平台定位精度 Platform Positioning Accuracy	≤ ±2μm
平台重复定位精度 Platform Repeated Positioning Accuracy	≤ ±1.5μm
设备尺寸 Device Dimension	L1865mm x W2275 mm x H2000mm (不附带信号灯尺寸 Without laminated lamp dimension)
裂片模组 Breaking Module	实际方案可选配机械/CO ₂ 模组，可能会增加设备尺寸 Mechanical /CO ₂ modules could be selected for the actual solution, which only increase the size of the equipment impact.

玻璃激光钻孔机

Laser drilling machine for Glasses



该设备广泛应用于各类摄像头模组保护盖、药玻打孔、玻璃打孔、玻璃切割等应用，采用海目星自主开发的可变焦光路，配备精密加工平台、特殊脉宽的激光器，在脆性材料内部形成小范围高温烧蚀效应，应用高效除尘结构完成粉尘快速抽除，能确保高效率、高精度达成打孔和切割要求，实现极小的崩边和锥度效果。广泛应用于玻璃的打孔、外形切割工艺应用，相较于传统机械作业，该系统具备了非接触式、无耗材的加工优势。

Equipment widely used in multiple kinds of camera module protection cover, medicine glass drilling, glass drilling, glass cutting etc., applications, such as the Hymson self-developed variable zoom optical path, equipped with sophisticated processing platform, special pulse width of laser, small scale high temperature is formed within the brittle material ablation effect and application of efficient dust structure to complete a quick smoke dust, To ensure high efficiency and precision requirements of drilling and cutting, also achieve minimal edge chipping and taper effect. Widely used in glass drilling, shape cutting process applications, compared with traditional mechanical operations, the system has the advantages of non-contact, no consumables processing.

Applications 应用

- 摄像头模组保护窗、透镜、药玻制品和玻璃结构件等的打孔和切割。
- 可实现较大厚度的一次打孔成型，并支持异形孔加工。
- 自动落孔，无需额外落孔装置。
- Camera module protection cover, medicine glass and glass structure drilling and cutting etc.,
- It can realize one punch forming with large thickness and support processing of special-shaped holes.
- Automatic hole drop, no additional hole drop device needed.

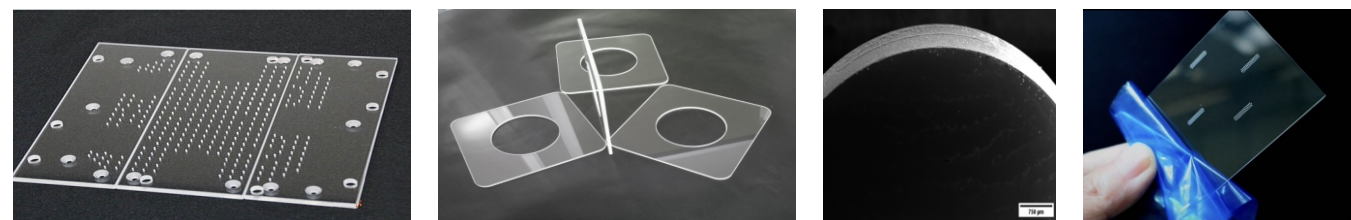

Equipment Feature 设备特点

- 采用大理石精密平台，稳定承载，耐腐蚀。
- 使用直线电机搭配光学尺全闭环驱动加工平台，易维护、精度高。
- 特殊脉宽激光器，加工热效应小，特别适合快速精密打孔。
- 采用进口真空发生元件，保证产品吸附定位稳定性。
- 配置自动聚焦对位CCD及视觉镜头，能精确识别各类Mark点。
- 配置全自动上下料结构，减少人工操作，大幅提高产能和质量。
- Adopt marble precise platform, stable load bearing, corrosion resistance.
- Use linear motor with optical ruler full closed loop drive machining platform, easy maintenance, high precision.
- Special pulse width laser, processing heat effect is small, especially suitable for fast and precise drilling.
- The imported vacuum generating element ensures the stability of product adsorption and positioning.
- Equipped with automatic focusing CCD and visual lens, it can accurately identify all kinds of Mark points.
- Automatic loading and unloading structure, reduce manual operation, greatly improve productivity and quality.

Parameters 产品参数

项目名称 Item	技术参数 Parameter
设备型号 Device Model	HP-ND030
激光器功率 Laser Power	30/50W
激光波长 Laser Wavelength	532 nm
脉冲频率 Pulse Frequency	50-150KHz
脉冲宽度 Pulse Width	≤7ns
光束质量 Beam Quality	M ² <1.3
冷却方式 Cooling Mode	水冷 Water Cooling
切割范围 Cutting Range	520mm x 520mm (可定制 Customization optional)
扫描速度 Scanning Speed	0-3000mm/s可调 Adjustable
切割厚度 Cutting Thickness	≤ 6mm (材料需表面光滑透明 The material surface should be smooth and transparent)
边缘崩边 Edge Chipping	≤ 150μm
切割速度 Cutting Speed	≥10mm/s@1mm厚材 Thick material (与材质特性有关 Related with material properties)
平台定位精度 Platform Positioning Accuracy	≤ ±2μm
平台重复定位精度 Platform Repeated Positioning Accuracy	≤ ±1.5μm
电源规格 Power Supply Specification	AC220V/<5KW
设备尺寸 Device Dimension	L1550mm x W1600 mm x H1800mm (不带信号灯尺寸 Without laminated lamp dimension)

光伏玻璃打孔机

Laser Drilling Machine For Photovoltaic

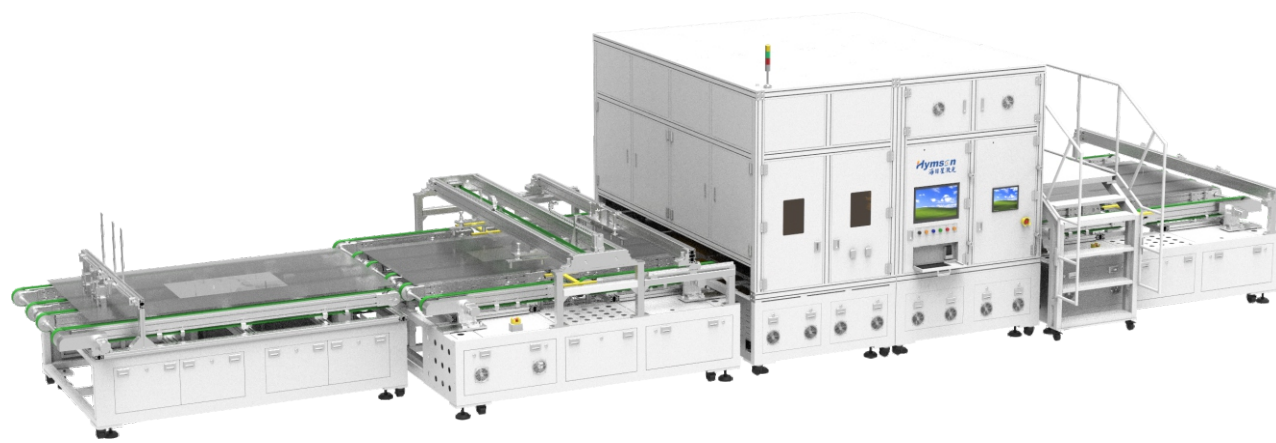

该设备适用于光伏压延玻璃、浮法玻璃圆孔、异形孔等打孔作业。可实现宽体/窄体出入料，配备输送结构，可嵌入流水线自动化作业。配备海目星自主设计的控制系统、窄脉宽激光器、定位系统以及高速扫描振镜以及涂布系统、自动上下料及旋转模组，可实现高速打孔作业，相较传统作业方式，具备更细腻的空边缘效果，更高的作业效率。

The equipment is suitable for photovoltaic calendered glass, float glass round hole, special-shaped hole and other drilling operations. Wide/narrow body feeding can be realized, equipped with a conveyor structure, and can be embedded in the assembly line for automated operations. Equipped with Hymson self-designed control system, narrow pulse width laser, positioning system and high-speed scanning galvanometer and coating system, automatic loading and unloading and rotating module, it can realize high-speed drilling operation, compared with the traditional operation mode, with a more delicate hollow edge effect and higher operation efficiency.

Equipment Feature 设备特点

- 多头加工，高效率，产能5-5.5片/分钟。
- 自动化作业，无缝连接流水线。
- 支持宽/窄体上下料。
- 支持多种异形孔加工。
- 支持信息追溯管理。
- 内置电源稳压器，安全保护设备电器，稳定可靠。
- 自主研发的切割软件，易学易用，可由客户选择订制功能。
- Multi-head processing, high efficiency, yield 5-5.5 tablets / min.
- Automate operations and seamlessly connect pipelines.
- Supports wide/narrow body loading and unloading.
- Support a variety of special-shaped hole machining.
- Support information traceability management.
- Built-in power regulator, safety protection equipment electrical appliances, stable and reliable.
- Self-developed cutting software, easy to learn and easy to use, can be customized by the customer' choice

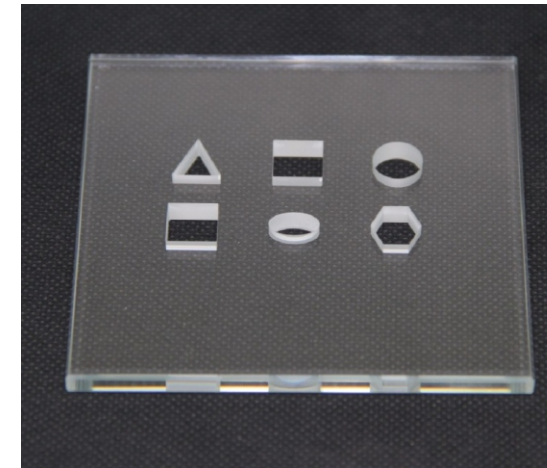

Parameters 产品参数

项目名称 Item	技术参数 Parameter
设备型号 Device Model	HP-NA0903
激光器功率 Laser Power	80/100W@IR; 30W@GR
激光波长 Laser Wavelength	1064nm/532nm
脉冲频率 Pulse Frequency	1-3000KHz@IR; 50-150KHz@GR
脉冲宽度 Pulse Width	2-50ns@IR; ≤7ns@GR
崩边尺寸 Chipping Size	<400um@IR; <200um@GR
冷却方式 Cooling Mode	水冷 Water Cooling
扫描速度 Scanning Speed	IR:40mm/s@1mm厚材 Thick material GR: ≥10mm/s@1mm厚材 Thick material
切割厚度 Cutting Thickness	≤5mm
加工孔径 Cutting Apertures	3-30mm
加工幅面 Cutting Range	600x900mm-1400x2500mm
加工孔间距 Hole Spacing	≥200mm
加工精度 Processing Accuracy	≤±0.2mm (与玻璃来料实际情况有关 Related to the actual situation of glass incoming materials)
加工效率 Processing Efficiency	≥5片/min (与加工形貌、孔位布局有关)
设备尺寸 Device Dimension	11500mm x 3200mm x 2500mm 不附带信号灯、电脑荧屏尺寸 Exclude signal lamp, computer screen size

C系列 CW光纤激光焊接机

Cseries CW Laser Welding



Equipment Feature 设备特点

- 单连续光纤激光器，可实现点焊、螺旋焊、摆动焊等效果。
- 高能量密度，可以焊接铜、铝等高反材料。
- 振镜+同轴视觉定位+三轴电动平台，集大幅面与高精度于一体。
- 电光转换率30%，功耗低。
- 另有配线模组，用于适配自动产线。
- Single CW fiber laser can realize spot welding, spiral welding and swing welding.
- High energy density, can weld Cu, Al and other high reflexes.
- Galvanometer + coaxial vision positioning + three axis servo platform, integrating large format and high precision.
- The electro-optic conversion rate is 30%, and the power consumption is low.
- There are also wiring modules for automatic production line.



CW激光器具有光束质量高、易维护、高可靠、长寿命等特点，功率范围广，从百瓦级到千瓦级，广泛应用于手机、平板、锂电池、传感器、医疗器械等产品的精密焊接；以及动力电池、汽车等行业的高功率厚板焊接；配合激光焊接头、振镜、运动平台、机器人等，可实现各种自动化焊接。

CW laser has the characteristics of high beam quality, easy maintenance, high reliability and long service life. It has a wide power range, ranging from 100 watts to kilowatts. It is widely used in the precision welding of mobile phones, flat plates, lithium batteries, sensors, medical devices and other products; as well as high-power thick plate welding in power batteries, automobiles and other industries; with laser welding joints, galvanometer, motion platform, robot, etc, All kinds of automatic welding can be realized.



TWS电池壳盖焊接
Lithium battery lug

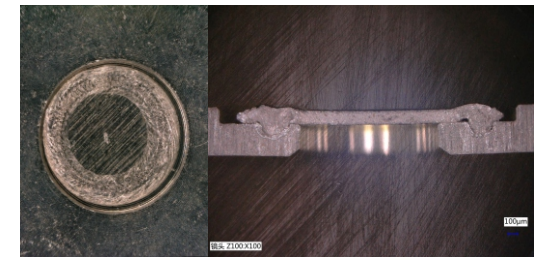

密封钉焊接
Sealing nail welding

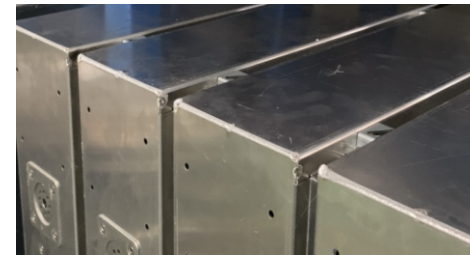

铝机箱焊接
Welding of aluminum case

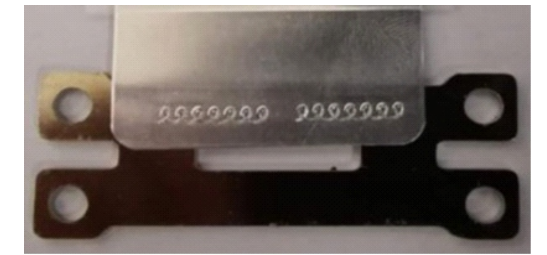

汇流排焊接
Bus bar welding

Parameters 产品参数

项目名称 Item	技术参数 Parameter
激光波长 Laser Wavelength	1080nm
激光输出功率 Laser Output Power	300W - 6000W
功率稳定性 Power Stability	5%
加工方式 Processing Method	振镜/出射头 Galvanometer welding/Fixed ejecting head
扫描范围 Scanned Area	100 x 100mm (可选 Optional)
平台运动范围 Platform Motion Area	200 x 300mm (标准工作台 Standard Workbench)
电力需求 Power Requirement	AC220V±10% 50Hz
冷却方式 Type of Cooling	风冷 Air Cooling
外形尺寸 Machine Size	L1050mm x W800mm x H1750mm 外观以实际产品为准 Product appearance depends on actual products
工作环境温度 Working Environment Temperature	10-35°C
工作环境湿度 Working Environment Humidity	40%-80%

Q系列 QCW激光焊接机

Q Series QCW Laser Welding



Equipment Feature 设备特点

- 高性能QCW激光器，专为3C精密焊接开发。
- 高精度振镜。
- 同轴视觉定位系统。
- 三轴伺服焊接平台：X×Y×Z=400×200×300mm
- 风冷免维护。
- High quality laser source specializes in 3C precise welding.
- Coaxial visual positioning system.
- High precision galvanometer.
- Triaxial servo motor motion platform:
X-400mm, Y-200mm, Z-300mm.
- Air cooling, maintenance-free.

Applications 应用

广泛应用于3C行业手机、平板、笔记本、穿戴产品、锂电池、元器件等产品的精密焊接，结合海目星焊接控制系统，可实现高精度、高效率的激光焊接加工。

It is widely used in precision welding of mobile phone, tablet, notebook, wearable products, lithium battery, components and other products in 3C industry. Combined with Hymson welding control system, high precision and high efficiency laser welding processing can be realized.



手机结构件
Mobile phone structure



摄像头支架
Camera bracket



指纹模块
Fingerprint module



手机中框
Phone frame



软包电池极耳
Lug laser welding



TYP-C
TYP-C



振动马达
Vibrating motor



精密电机
Uav motor



耳机
Headset

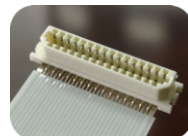

连接器
Connector

焊接模式 Mode	图示 Sample	应用 Application
脉冲点焊 Multiple-impulse welding		
连续焊接 Continuous welding		
螺旋线 Spiral line welding		
摆动焊接 Wobble Welding		无摆动 有摆动
能量随动焊接 Energy servo welding		有随动 无随动

Parameters 产品参数

项目名称 Item	技术参数 Parameter
激光波长 Laser Wavelength	1070nm
最大激光输出功率 Maximum Laser Output Power	150W 300W
峰值功率 Peak Power	1KW/1.5KW 3KW
最大脉冲能量 Maximum Pulse Energy	25J 30J
脉冲宽度 Pulse Width	0.1ms-50ms
脉冲频率 Impulse Frequency	1Hz-2KHz
功率稳定性 Power Stability	2%
加工方式 Processing Method	振镜/出射头 Galvanometer welding/Fixed ejecting head
扫描范围 Scanned Area	100 x 100mm (可选 optional)
平台运动范围 Platform Motion Area	200 x 300mm (标准工作平台 Standard Workbench)
电力需求 Power Requirement	AC220V±10% 50Hz
冷却方式 Type of Cooling	风冷 Air Cooling
外形尺寸 Machine Size	L1050mm x W800mm x H1750mm 外观以实际产品为准 Product appearance depends on actual products

N系列 纳秒激光焊接机

N Series Nanosecond Laser Welding



Equipment Feature 设备特点

- 应用了激光脉冲扫描焊接原理。
- 激光能量按指定轨迹均匀分布，避免了长脉能量呈高斯分布的缺陷，在薄片类焊接时不容易击穿。
- 焊点由多个高峰值的纳秒脉冲组成，提高了在有色金属表面的吸收率，因此可以稳定焊接铜、铝等有色金属。
- Laser pulse scanning welding principle is applied.
- The laser energy is evenly distributed according to the specified trajectory, which avoids the defect that the long pulse energy is gaussian distribution, and it is not easy to be broken down in the thin section welding.
- The solder joint is composed of multiple nanosecond pulses of peak values, which improves the absorption rate on the surface of non-ferrous metals and thus can stabilize the welding of copper, aluminum and other non-ferrous metals.

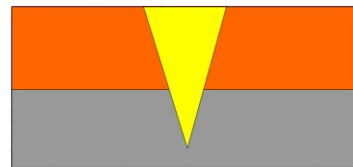

长脉冲激光熔池
呈V字形, 易击穿, 强度低
Long pulse laser bath
V-shaped, easy to break
down, low strength

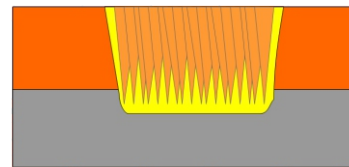

纳秒激光熔池
呈平底状, 不易击穿, 强度高
Nanosecond laser puddle
Flat bottom, not easy to break
down, high strength

Applications 应用

广泛适用于异种有色金属薄片的焊接，尤其适用于消费类电子行业的新器件焊接。

Widely applicable to the welding of heterogeneous non-ferrous metal sheet, especially for the welding of new components in the consumer electronics industry.

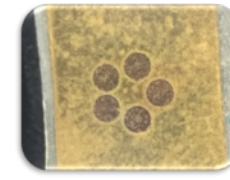

Cu+SS

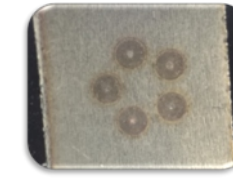

SS+Al



Ni+Al

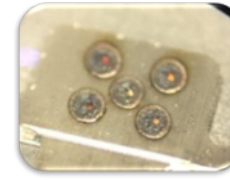

Cu+SS

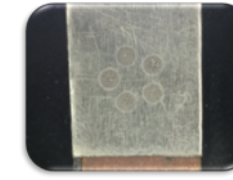

Al+Red Cu

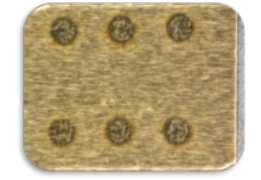

Cu+Mg

Parameters 产品参数

项目名称 Item	技术参数 Parameter			
激光波长 Laser Wavelength	1070nm			
激光输出功率 Laser Output Power	70W	100W	150W	200W
最大脉冲能量 Maximum Pulse Energy	1.0mJ		1.5mJ	
脉冲宽度 Pulse Width	1-450ns			
脉冲频率 Impulse Frequency	1KHz-2KHz			
功率稳定性 Power Stability	3%			
加工方式 Processing Method	振镜/出射头 Galvanometer welding/Fixed ejecting head			
扫描范围 Scanned Area	100 x 100mm (可选 optional)			
平台运动范围 Platform Motion Area	400 x 200 x 300mm (标准工作平台 Standard Workbench)			
电力需求 Power Requirement	AC220V±10% 50Hz			
冷却方式 Type of Cooling	风冷 Air Cooling			
外形尺寸 Machine Size	L1050mm x W800mm x H1750mm 外观以实际产品为准 Product appearance depends on actual products			

P系列 塑料激光焊接机

P Series Plastic Laser Welding



Equipment Feature 设备特点

- 采用透射焊接原理，熔池在材料内部，表面无痕。
 - 密封性能好。
 - 焊接强度等于或高于母材。
 - 功耗低，无噪音，无耗材，免维护。
 - 采用高效率半导体激光器，功率稳定，功耗低。
 - 激光、视觉、测温三合一焊接头。
 - 焊接温度实时反馈。
 - 可选环形光斑，实时测温更准确。
 - 光斑大小可变。
 - 三轴伺服焊接平台。
- Using the principle of transmission welding, the molten pool is inside the material, and the surface has no trace.
 - Good sealing performance.
 - The welding strength is equal to or higher than the base metal.
 - Low power consumption, no noise, no consumables, maintenance-free.
 - Using high efficiency semiconductor laser, stable power and low power consumption
 - Laser, vision, temperature measurement three-in-one welding head.
 - Real-time feedback of welding temperature.
 - Optional ring light spot, real-time temperature measurement is more accurate.
 - Variable spot size.
 - Three-axis servo welding platform.

Applications 应用



980nm激光 耳机焊接
980nm Laser
earphone welding

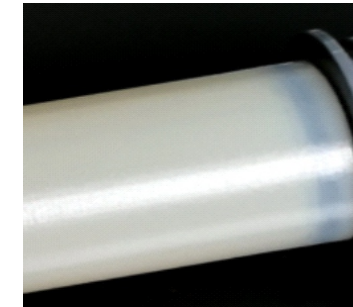

管材焊接
Pipe welding



915nm激光 水泵壳体焊接
915nm Laser
Water pump shell welding

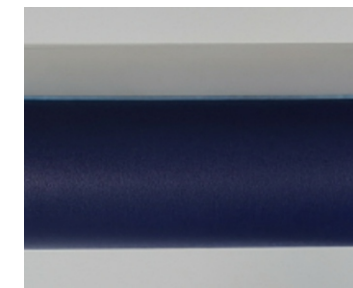

915nm激光 壶身焊接
915nm Laser
Pot body welding

Parameters 产品参数

项目名称 Item	技术参数 Parameter
激光波长 Laser Wavelength	915nm
激光平均功率 Average Laser Power	80/100W
激光模式 Laser Mode	CW
能量稳定性 Energy Stability	3%
温控精度 Temperature Control Accuracy	5%(与材料与结构有关) With relative to material and structure
平台行程 Platform Stroke	X/Y/Z = 400 x 200 x 300mm
平台重复精度 Platform Repeatability	± 0.02mm
电力需求 Power Requirement	AC220V ± 10% 10A 50HZ
冷却方式 Cooling Method	风冷 Air cooling
外形尺寸 Dimension	L1050mm x W800mm x H1750mm

Q系列 双通道激光焊接模组

Q Series Double Channel Laser Welding Module



Equipment Feature 设备特点

- 双通道QCW激光器实现了一台激光器输出两路独立控制激光。
- 多角度/多工位并行焊接, 加工效率高。
- 无外置光路, 风冷方式, 免维护。
- 体积紧凑, 集成度高。
- 性能稳定, 可长时间工作。
- A dual-channel QCW laser can output two independent control lasers.
- Multi-angle/multi-station parallel welding, high processing efficiency.
- No external light path, air cooling, maintenance-free.
- Compact volume, high integration.
- Stable performance, can work for a long time.

Applications 应用

广泛应用于3C行业手机、平板、笔记本、穿戴产品、锂电池、元器件等产品的精密焊接, 特别适用于有多角度、多工位同时焊接需求产品, 如Type-C连接器焊接。

It is widely used in precision welding of 3C industry mobile phones, tablets, notebooks, wearable products, lithium batteries, components and other products, especially suitable for multi-angle, multi-station simultaneous welding products, such as Type-c connector welding.

Applications scenarios 应用场景

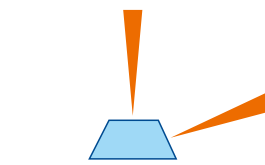

多角度焊接
Multi-angle welding

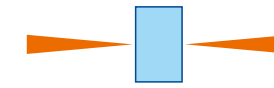

对称焊接
Symmetrical welding

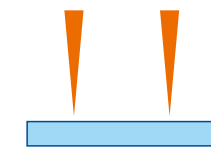

双头并行高效焊接
Double head parallel
efficient welding

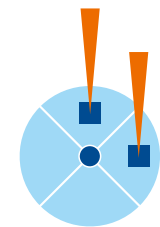

多工位焊接
Multi-station welding

Parameters 产品参数

项目名称 Item	技术参数 Parameter
激光波长 Laser Wavelength	1070nm
最大激光平均功率 Maximum Laser Output Power	100W*2
峰值功率 Peak Power	750W*2
最大脉冲能量 Maximum Pulse Energy	7.5J
光束质量 Beam Quality	M ² <1.1
脉冲宽度 Pulse Width	0.1-50ms
脉冲频率 Pulse Frequency	1Hz-5000Hz
能量稳定性 Energy Stability	≤2%
振镜扫描范围 Scanned Range	100mm x 100mm (optional)
CCD像素 CCD Pixel	500W (optional)
视觉定位精度 Visual Positioning Accuracy	±0.01mm
光纤长度 Fiber Length	5M
电力需求 Power Requirement	AC220V ± 10% 10A 50Hz
冷却方式 Type of Cooling	风冷 Air cooling
激光器外形尺寸 Laser Machine Size	L578mm x W390mm x H136mm

动力电池顶盖激光焊接机

Laser Welding Machine for Power Battery Cover



Equipment Feature 设备特点

- 可选单模激光或点环形光斑复合激光器。
- 点环形光斑激光能有效抑制焊接飞溅、气孔,焊缝质量高。
- 双工位作业,加工效率高。
- 可选振镜或准直式焊接头,兼顾适配多种焊接应用。
- 可选配搭载激光焊接缺陷检测系统,有效排除焊接不良。
- 可通过更换焊接夹具,快速换型,设备兼容性强。
- SMF/spot&ring Compound laser.
- Point ring spot laser can effectively restrain welding spatter and porosity, and the weld quality is high.
- Double station operation, high processing efficiency.
- Galvanometer/Collimating welding head, suitable for a variety of welding applications.
- Optional equipped with laser WDD system, effectively eliminate welding defects.
- The welding fixture can be replaced, fast change, high equipment compatibility.

Applications 应用

应用于动力电池顶盖结构件防爆阀、极柱、引脚、波翼激等激光焊接。
Used for laser welding of explosion-proof valve, pole, pin, wave wing etc.



防爆阀
Anti-explosion valve

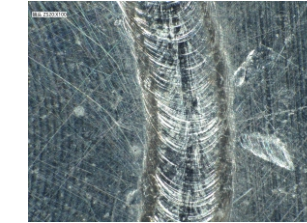

铝极柱
Al pole column

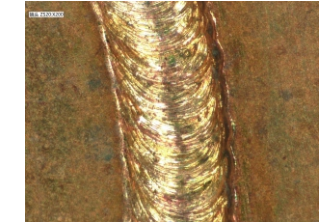

铜极柱
Cu pole column

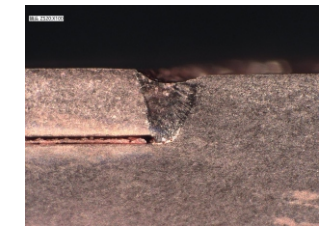
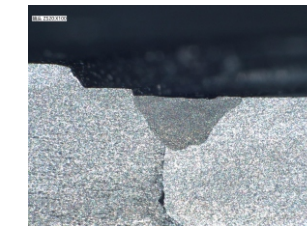
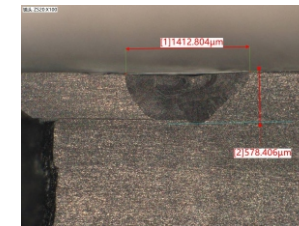

Parameters 产品参数

项目名称 Item	技术参数 Parameter
激光器类型 Type of Laser Machine	SMF/Spot&Ring Compound laser (optional)
激光波长 Laser Wavelength	1070nm/915nm&1070nm
输出功率 Output Power	1500W-4000W
功率稳定性 Power Stability	<3%
加工头 Processing Head	Galvanometer / Collimating welding head (optional)
工作范围 Working Range	X x Y x Z = 750mm x 750mm x 100mm
平台重复定位精度 Positioning Accuracy	±0.02mm
电力需求 Demand for Rlectricity	AC380V/20A/50Hz
冷却方式 Type of Cooling	水冷 Water cooling
设备尺寸 Machine Size	L1300mm x W1300mm x H2000mm

料带激光切焊一体机

Material belt laser cutting and welding machine



Equipment Feature 设备特点

- 集激光切割+激光焊接于一体。
- 一键裁切、自动焊接。
- 产线免停机，新旧料带无缝衔接。
- 支持脱机运行，无需等待电脑开机。
- 体积紧凑，机动性强。
- 风冷方式，免维护。
- Set laser cutting + laser welding in one.
- One-click cutting, automatic welding.
- The production line is downtime-free, and the new and old material belts are seamlessly connected.
- Support offline operation, no need to wait for the computer to boot.
- Compact size and high maneuverability.
- Air-cooled, maintenance-free.

Applications 应用

应用于金属料带冲压、电镀、组装线体新旧料拼接焊，减少停机人工换料时间。

It is applied to metal strip stamping, electroplating, assembly line body new and old material splicing welding, reducing downtime and manual material change time.

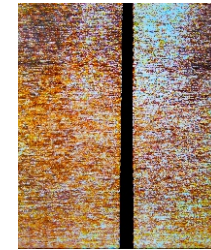

料带激光切割
Material belt laser cutting

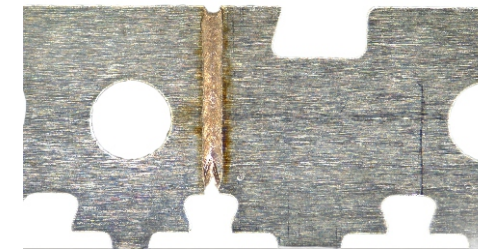

料带激光焊接
Material belt laser welding

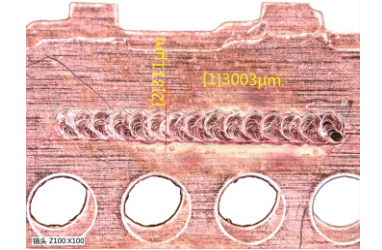

Parameters 产品参数

项目名称 Item	技术参数 Parameter
激光波长 Laser Wavelength	1070nm
输出功率 Output Power	1000-1500W
光束质量 Beam Quality	$M^2 < 1.1$
功率稳定性 Power Stability	$\leq 2\%$
兼容材料(切+焊) Compatible with The Material(Cutting+Welding)	SUS:0.05-0.5mm CU:0.05-0.5mm
振镜扫描范围 Scanned Range	85 x 85mm (Optional)
CCD像素 CCD Pixel	500W (Optional)
视觉定位精度 Visual Positioning Accuracy	$\pm 0.01\text{mm}$
电力需求 Power Requirement	AC220V $\pm 10\%$ 10A 50Hz
冷却方式 Type of Cooling	风冷 Air cooling
激光器外形尺寸 Laser Machine Size	L578mm x W390mm x H136mm

S系列 激光送丝焊锡机

S Series Laser Tin Wire Soldering



Equipment Feature 设备特点

- 支持温控模式，功率模式两种。
- 激光、测温、视觉三合一焊接头。
- 光斑大小0.6~3mm可调。
- 最小焊盘0.6mm。
- 左右双工位。
- 锡焊专用软件，可订制服务。
- Temperature/power control mode for option.
- Temperature measurement and visual combined for soldering.
- Adjustable spot dia. 0.6~3mm.
- Minimum soldering pad 0.6mm.
- Left/right dual-station.
- With customized service for the specified soldering software.

Applications 应用

锡量准确，焊点无拉尖，表面圆滑。可直接替代电烙铁，广泛用于3C行业，电机行业，软包电池等领域的软硬板、特殊器件的焊锡。

The amount of tin is accurate, the solder joints are not pointed, and the surface is smooth. It can directly replace electric ferrochrome, widely used in soldering of soft and hardboards and special devices in the fields of 3C industry, motorindustry, soft pack battery, etc.

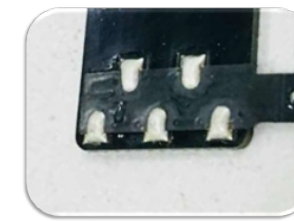

软包电池FPC
Battery FPC



电池汇流排
Battery bus bar

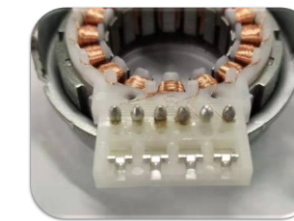

电机绕线柱
Winding pin Soldering

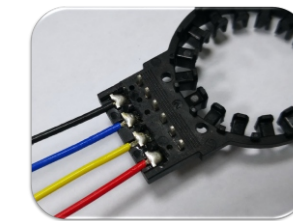

线端子
Wire Terminal



异型焊盘焊接
Deformed Pad Soldering



电子转子
Motor Coil



无线充电线圈
Wireless Coil

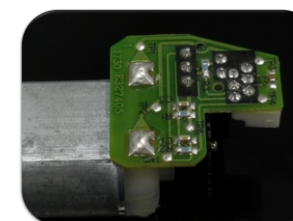

电机FPC
Motor PCB

Parameters 产品参数

项目名称 Item	技术参数 Parameter
激光波长 Laser Wavelength	450nm / 915nm
激光功率 Laser Power	50W/80/100/150W
锡丝直径 Tin Wire Diameter	0.3~0.8mm
机械重复定位精度 Mechanical Repeat Positioning Accuracy	±0.02mm
视觉定位系统 Visual Positioning System	±0.02mm
电力需求 Power Requirement	AC220V 10A
冷却方式 Type of Cooling	风冷 Air Cooling
外形尺寸 Machine Size	L1050mm x W800mm x H1750mm 外观以实际产品为准 Product appearance depends on actual products

J 系列 激光锡球焊锡机

J Series Laser Solder Ball Jetting



Equipment Feature 设备特点

- 锡球喷射焊，锡量准确，无松香。
- 效率高，可达10000点/H。
- 焊点位置精度<0.05mm。
- 锡球直径0.15~1.2mm。
- 最小焊盘可达0.4mm。
- Precise control of tin amount through solder ball jetting, and no flux.
- High efficiency up to 10,000 point/ hr.
- Accuracy of welding joint < 0.05mm.
- Solder ball dia. : 0.15~1.2mm.
- Minimum pad size: 0.4mm.

Applications 应用

适用于手机摄像头模组焊接，晶圆引线焊接，密脚连接线焊接，半导体BGA植球及传感器等领域的焊接。

Suitable for soldering of mobile phone camera module, precision FPC soft board, special precision devices, semiconductor BGA ball and sensor.



PCB焊接
PCB Soldering



汽车雷达引脚焊接
Auto Radar Lead

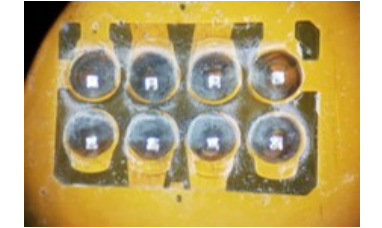

FPC引线焊接
FPC Lead

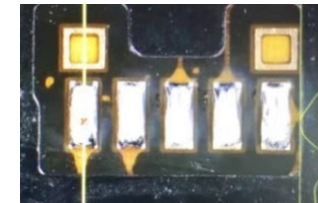

电池FPC软过孔焊接
Battery FPC Punch

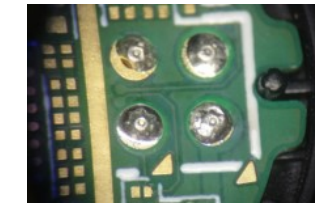

PCB过孔引脚焊接
PCB Punch Lead

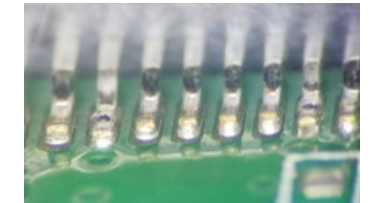

高密度引线焊接
Hi-density Lead

Parameters 产品参数

项目名称 Item	技术参数 Parameter
激光波长 Laser Wavelength	1070nm
激光输出功率 Laser Output Power	75-100W
锡球规格 Tin Ball Specification	φ 0.1-1.2mm
机械重复定位精度 Mechanical Repeat Positioning Accuracy	± 0.01mm
视觉定位系统 Visual Positioning System	CCD:5Million Pixels
电力需求 Power Requirement	AC220V±10% 50Hz
冷却方式 Type of Cooling	风冷 Air Cooling
外形尺寸 Machine Size	L1250mm x W950mm x H1800mm 外观以实际产品为准 Product appearance depends on actual products

导电胶点胶机

Conductive Glue Dispensing Machine



Equipment Feature 设备特点

- 胶量大小粗细、涂胶速度、点胶时间、停胶时间皆可参数设定、出胶量稳定，不漏滴胶。
- CCD辅助程式编辑及教导功能使坐标轨迹位置能实时追踪显示，缩短程序编辑时间，大大提高编程效率。
- 测高补偿功能，点胶过程Z轴自动调整，适应产品形变，避免撞针。
- 伺服螺杆供胶系统，出胶压力稳定。
- 智能断胶功能，防止拉胶，即节省胶，又减少修胶工序。
- 海目星的高频率陶瓷点胶阀使点胶的起点和结束点胶量控制更精确。
- The size and thickness of glue, the speed of glue application, glue dispensing time and glue stopping time can all be set. Stable amount of glue, no leakage of glue.
- CCD assisted program editing and teaching functions enable realtime tracking and display of coordinate track position, shorten program editing time and greatly improve programming efficiency.
- Height measurement compensation function, z-axis automatic adjustment during dispensing process, to adapt to product deformation and avoid needle impact.
- Servo screw glue supply system, stable glue discharge pressure.
- Intelligent glue breaking function, prevent glue pulling, save glue and reduce glue repairing process.
- High frequency ceramic dispensing valve of Neptune makes the starting and ending of dispensing more accurate.

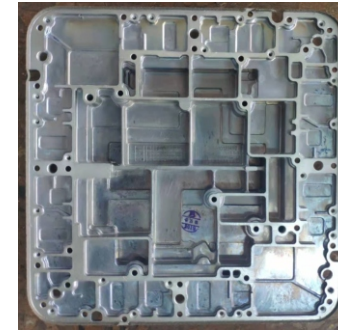

Applications 应用

导电胶点胶机:由X,Y,Z三轴组成,控制系统由伺服马达+滚珠丝杆组成,采用电脑控制,主要用于电子产品方面的点胶如通讯类产品外壳,机站盒,继电器,开关,数码相机,手机主板,电脑主板,计算器,手机电池组件,DVD,LED及半导体产业等,针头智能跟随路径自动作方向旋转,使落在工件上的导电胶形成三角形分布,根据工艺要求,圆形点胶和三角形点胶方式可随时切换。

Conductive glue dispensing machine with the X, Y, Z of three axis, its control system consists of a servo motor + ball screw, adopt PC control. Which mainly used in electronic products, such as communication products shell, machine box, relays, switches, digital camera, mobile phone mainboard, computer mainboards, computer, mobile phone battery components, DVD, LED and semiconductor industries, needle intelligent direction along path automatically, make on the conductive glue on the workpiece form triangular distribution, Also, the triangle dispensing and circular points method can switch at any time according to the technological requirements.

Parameters 产品参数

项目名称 Item	技术参数 Parameter		
设备型号 Device Model	HZ-CGD210		
运动轴 Motion Axis	X轴 X-axis	Y轴 Y-axis	Z轴 Z-axis
驱动方式 Drive Mode	伺服电机+精密丝杆 Servo motor + Precision Screw		
工作范围 Processing Area	1000mm	800mm	150mm
最大移动速度 Max Motion Speed	1000mm/s	1000mm/s	500mm/s
重复定位精度 Positioning Repeatability Accuracy	±0.02mm	±0.02mm	±0.01mm
负载 Load	-	25kg	25kg
点胶阀类型 Dispensing Valve	陶瓷旋转阀 Ceramic rotary valve		
点胶阀数量 Valve Qty	1 set		
电源 Power	AC220V 10A		
供胶方式 Glue Supply	伺服供胶 Servo supply		
胶桶规格 Glue Package	600cc		
气压 Air Pressure	≥0.6MPa		
重量 Weight	<350kg		
外形尺寸 Machine size	W1600mm x D1400mm x H1800mm		

高速点胶机

High Speed Glue Dispenser



Equipment Feature 设备特点

- 创新结构设计, 设备占地面积较同类设备减少20%。
- 支持双阀异步点胶, 双阀同步点胶、AB双阀、单阀等模式。
- 可自由选配产品预加热、斜阀、4轴5轴、功能扩展背包等组件。
- 支持重量模式、点数模式、参数模式等多种点胶模式。
- 智能点胶软件, 支持撞针阀、喷射阀、螺杆阀等不同的点胶工艺需求。
- 支持2D、3D激光测高, 视觉胶路在线检测。
- 显示器内藏中置, 可升降结构, 整线操作不干涉。
- Innovative structural design, the equipment area is reduced by 20% compared with similar equipment.
- Double Valve Asynchronous Dispensing, Double Valve Synchronous Dispensing, AB Double Liquid Dispensing Valve, Single Valve, etc. supported.
- Optional components, including preheating, inclined valve, 4-axis and 5-axis, function extension backpack, etc.
- Various dispensing modes supported, including Weight Mode, No. of Points Mode, Parameter Mode, etc.
- The intelligent dispensing software supports different dispensing process requirements, such as impactor valves, injection valves, screw down valves, etc.
- 2D and 3D laser height measurement and online testing of visual sealant system supported.
- A lifting structure is hidden at the center inside the display. The operation of the whole line is not intervened in.

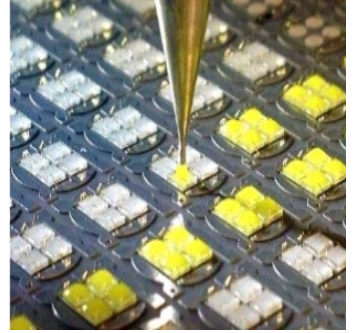

Applications 应用

- SMT点红胶、FPC封装、VCM模组点胶。
- 指纹识别模组封装、手机边框点热熔胶。
- IC边缘封装、FPC元件包封。
- PCB板防水行业组装等精密点胶场合。
- SMT Adhesive, FPC Encapsulating, VCM Module Dispensing.
- Hot melt glue for fingerprint recognition module encapsulating and cell phone's frames.
- IC edge encapsulating and FPC component encapsulating.
- Precision dispensing, such as waterproof industry assembly for PCBs, etc.

Parameters 产品参数

项目名称 Item	技术参数 Parameter
设备型号 Device Model	HZ-GH510A+B20A1:BA1:B22
点胶区域 Dispensing Area	单阀 Single valve:X400 / Y470/ Z60 (mm)
工作高度 Working Height	900±30mm
点胶阀类型 Dispensing Valve Type	气动/压电喷射阀 Pneumatic/Piezoelectric injection valve
阀嘴清洗方式 Valve Nozzle Cleaning Method	真空清洗 Vacuum Cleaning
轨道数量 Number of Tracks	1set
最大负载 Max Load	4kg/m均匀分布 4kg/m Evenly distributed
传送方向 Transmission Direction	L→R (R→L选配) L→R (R→L Matching)
流水线最大传输速度 Max Transmission Speed	300mm/s
流水线宽度调节 Width Adjustment	自动(50-500mm) Auto(50-500mm)
运动平台类型 Motion Platform Type	XY直线电机+Z轴伺服电机 XY linear motor + z-axis servo motor
最大移动速度 Max moving speed	1.2m/s
最大加速度 Max Acceleration	1g
定位精度 Repeatability	XY: ±0.01mm; Z: ±0.02mm
重复定位精度 Positioning Accuracy	XY: ±0.005mm; Z: ±0.01mm
双点胶阀 Double Dispensing Valve	双阀XYZ位置可独立补偿, 产能提高一倍 The XYZ position of double valve can be compensated independently, improve double production capacity;
激光高度检测 Laser Height Detection	自动校准工件Z向误差 Automatically calibrate the Z error of the workpiece
在线称重 Online Weighing	可自动校正调节出胶量; 精度±0.01mg Automatically adjust and adjust the glue output; accuracy is ±0.01mg
针嘴擦拭清洁 Wipe and Clean the Needle Nozzle	采用无尘带擦拭, 尤其适用高粘度胶水 Wipe with dust-free tape, especially for high viscosity glue
气压 Air Pressure	≥0.5MPa
设备尺寸 Machine Size	L690mm x D1400mm x H1600mm
电力需求 Power Demand	AC220V 10A

太阳能逆变器自动组装线

Automatic Assembly Line of Solar Inverter

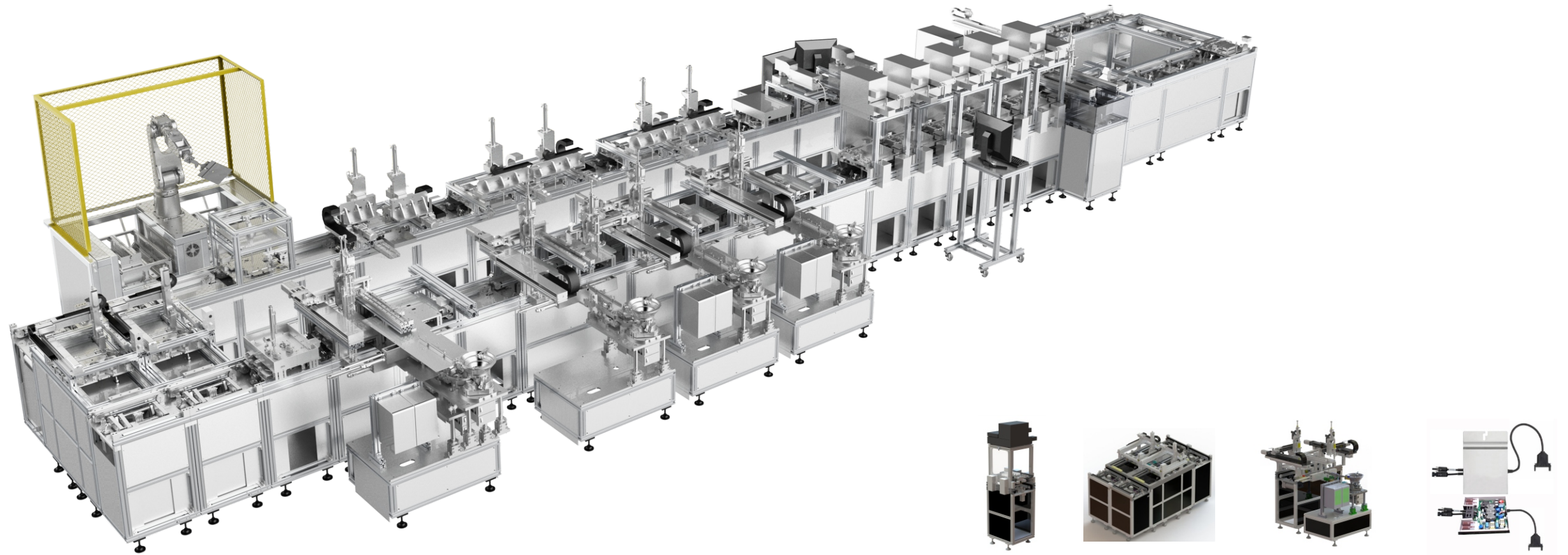

Equipment Feature 设备特点

- 生产效率高, 双班节省约40人。
- 速度快且稳定性强, 提高了产品后续测试环节的一次通过率。
- 标准化模块设计, 可随时调整, 扩展工位或升级。
- 生产数据自动保存, 和服务器联网。
- 采用CCD定位技术, 解决了产品在不同工位生产时, 位置精度的准确性。
- 采用RFID技术, 准确记录产品在各工位的生产信息, 确保了产品信息的可追溯性。
- The high production efficiency can save the manpower (40 persons) for two shifts.
- The fast speed and strong stability can improve the first pass yield of subsequent tests.
- Standard modular design can realize adjustment and extension of station or upgrading at any time.
- The production data can be saved automatically and connected with the server.
- The CCD positioning technology realizes the positioning accuracy during production at different stations.
- The RFID technology can record the production information of stations accurately and ensure the traceability of product information.

Parameters 产品参数

描述 Description	此设备用于太阳能逆变器的全自动组装线, 设备有50个模块组成, 含22个工位; 采用标准化模块设计, 随时调整, 扩展工位或升级, 生产数据自动保存, 和服务器联网。主要模组包括自动读码、激光打标、自动锁螺丝、耐压测试、自动点胶、CCD视觉检测、自动贴条码、自动检测良品与不良品等。 The machine is used for the full-automatic assembly line of solar inverter and composed of 50 modules (including 22 stations); the standard modular design can realize adjustment and extension of station or upgrading at any time. The production data can be saved automatically and connected with the server. The main module includes automatic code reading, laser marking, automatic screw fastening, withstand voltage test, automatic dispensing, CCD visual inspection, automatic bar code paste and automatic detection of OK and NG products.
UPH	400PCH/H
MTBA	≥120Min
MTBF	≥168H
额定电压 Rated Voltage	AC220V
额定电流 Rated Current	80A
气压 Air Pressure	0.6MPa~0.8MPa
设备尺寸 Machine Dimension	L12000mm x W1850mm x H1900mm

电源自动组装线

Power Automatic Assembly Line

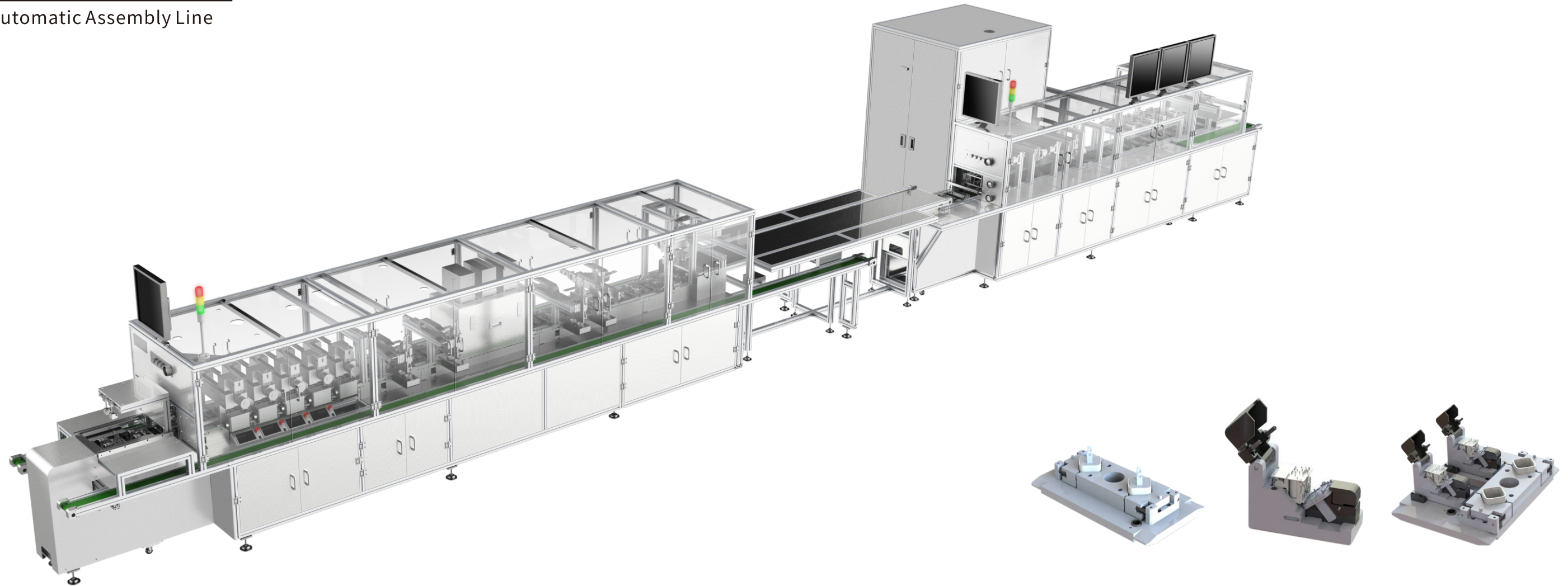

Equipment Feature 设备特点

- 目前有超过20条集自动焊锡、点胶、超声波铆接、检测、激光打标为一体的自动组装线应用于量产。
- 整机采用模块化设计,便于线体拆装、定制和运输。
- 多项专利应用其中,使该自动生产线的生产效率,良品率大大高于人工作业。
- More than 20 automatic assembly lines integrating automatic soldering, dispensing, ultrasonic riveting, testing and laser marking are applied to mass production.
- The modular design of complete machine is convenient for line changeover, customization and transportation.
- Efficiency and yield rate of automatic production line are much higher than manual due to its various patented technologies.

Parameters 产品参数

描述 Description	此设备用于手机电源产品自动组装;包括自动焊锡、CCD检测、点胶UV、UV胶固化、点777胶、超声波铆接、GAP、STEP检测等工位;采用标准化模块设计,方便工艺调整及设备升级;实时与服务器进行数据交换,及时对产品生产信息进行存档,确保了产品生产信息的准确性。 The machine is used for automatic assembly of mobile phone power products; it includes automatic soldering, CCD inspection, UV glue dispensing, UV glue curing, 777 glue dispensing, ultrasonic riveting, GAP and STEP inspection; the standard modular design is convenient for adjustment and machine upgrading; realize real-time data exchange with server, file the production information timely and ensure the accuracy of production information.
UPH	1250 PCS/H
MTBA	≥60 Min
MTBF	≥168 H
额定电压 Rated Voltage	AC220V
额定电流 Rated Current	50A
气压 Air Pressure	0.5MPa~0.7MPa
设备尺寸 Machine Dimension	L12500mm x W800mm x H1800mm

变压器自动组装线

Automatic Assembly Line of Transformer

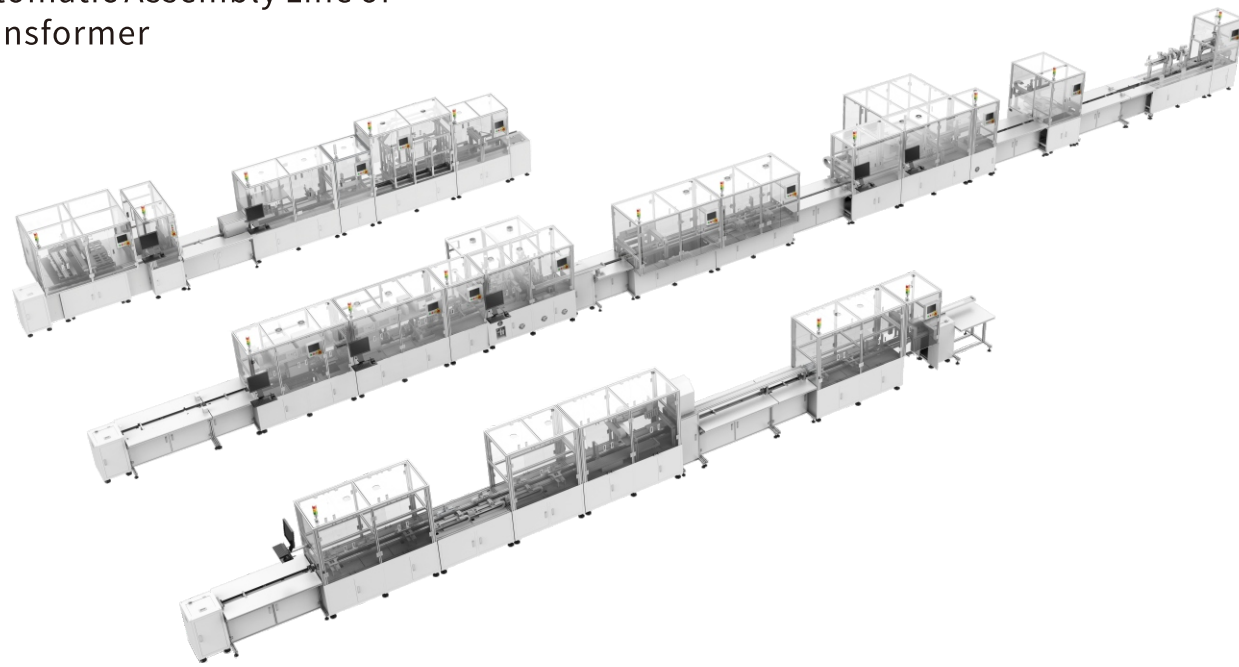

Equipment Feature 设备特点

- 为3C知名企业总计提供超过50条整线自动化生产线正在用于量产。
- 包括磁芯自动上料, 点A、B胶, 磁芯扣合, 电感测试, 自动浸锡, 自动点UV胶, 自动剪线, 自动激光去皮, 贴胶纸, 高压测试, 功能测试, 外观检查等模组。
- 高度标准化设计, 可低成本改造, 快速用于同类产品量产。
- More than 50 automatic production lines are provided for 3C enterprises, which are being used in mass production.
- It includes auto core loading, dispensing AB glue, Core assy, Inductance test, Auto dip-soldering, Auto UV glue dispensing, Auto wire cutting/laser stripping, Taping, Hi-pot test, Function test, Cosmetic inspection etc., modules.
- Highly standardized design, low-cost transformation, rapid mass production of similar products.

Parameters 产品参数

UPH	1200PCS/H
MTBA	30Min
MTBF	120H
停机时间 Downtime	3%
额定电压 Rated Voltage	220V50Hz
烤炉电压 Oven Voltage	380V
额定电流 Rated Current	230A
气压 Air Pressure	0.6MPa~0.7MPa
功率 Power	51KW
环境温度 Environmental Temperature	15-25°C
设备尺寸 Machine Dimension	L57000mm (42+12)xW2300mm

平面变压器自动化组装线

Planar Transformer Automatic Assembly Line

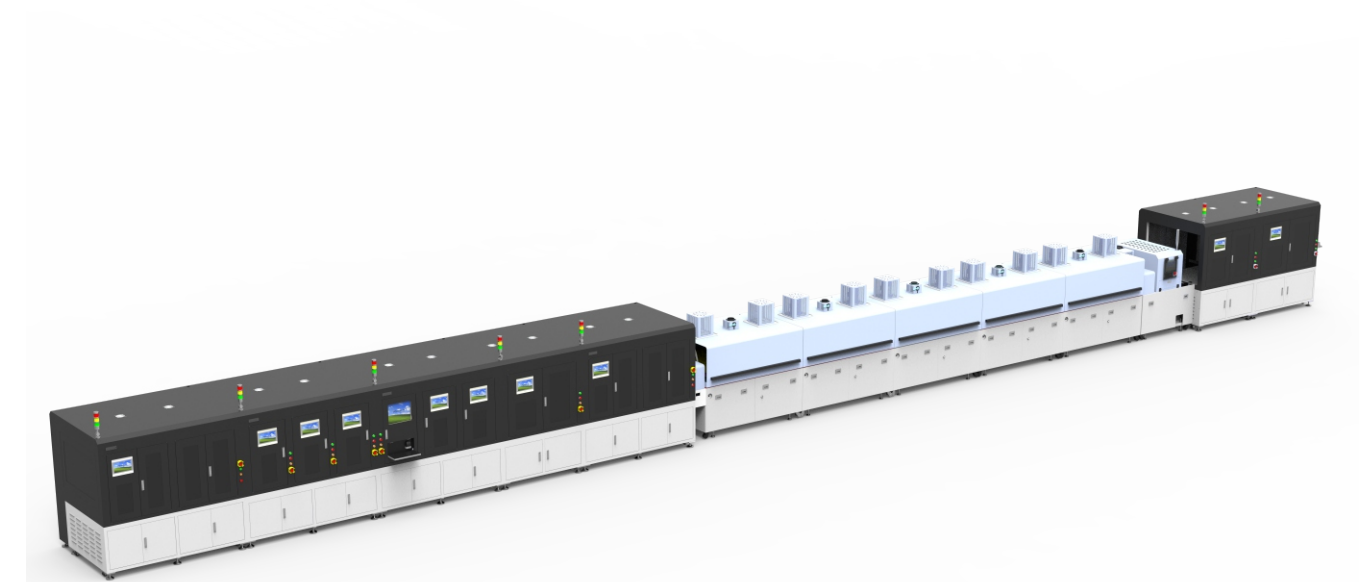

Equipment Feature 设备特点

- 适用于最新的氮化镓技术PCB板集成式变压器, 集自动组装及测试于一体的全自动化生产线。
- 主要包含磁芯上料、点胶、组装和电感测试、烘烤、治具解锁、测试、印字和下料等设备。
- 其中CORE & PCB实现全自动化组装。
- UPH: 每小时产能1000 Pcs至1500 Pcs。
- Used for automatic assembly production of planar transformers, replacing manual or semi-automatic operations.
- Mainly includes core loading, dispensing, core assembly and inductance testing, curing, fixture unblocking, testing, Ink-jetting and unloading.
- Among which CORE & PCB incoming materials feeding are fully automated.
- The completed equipment UPH covers more than 1,000 to 1500 options.

PCB防水镭射除胶智能装备

PCB Laser Glue-removal Intelligent Machine

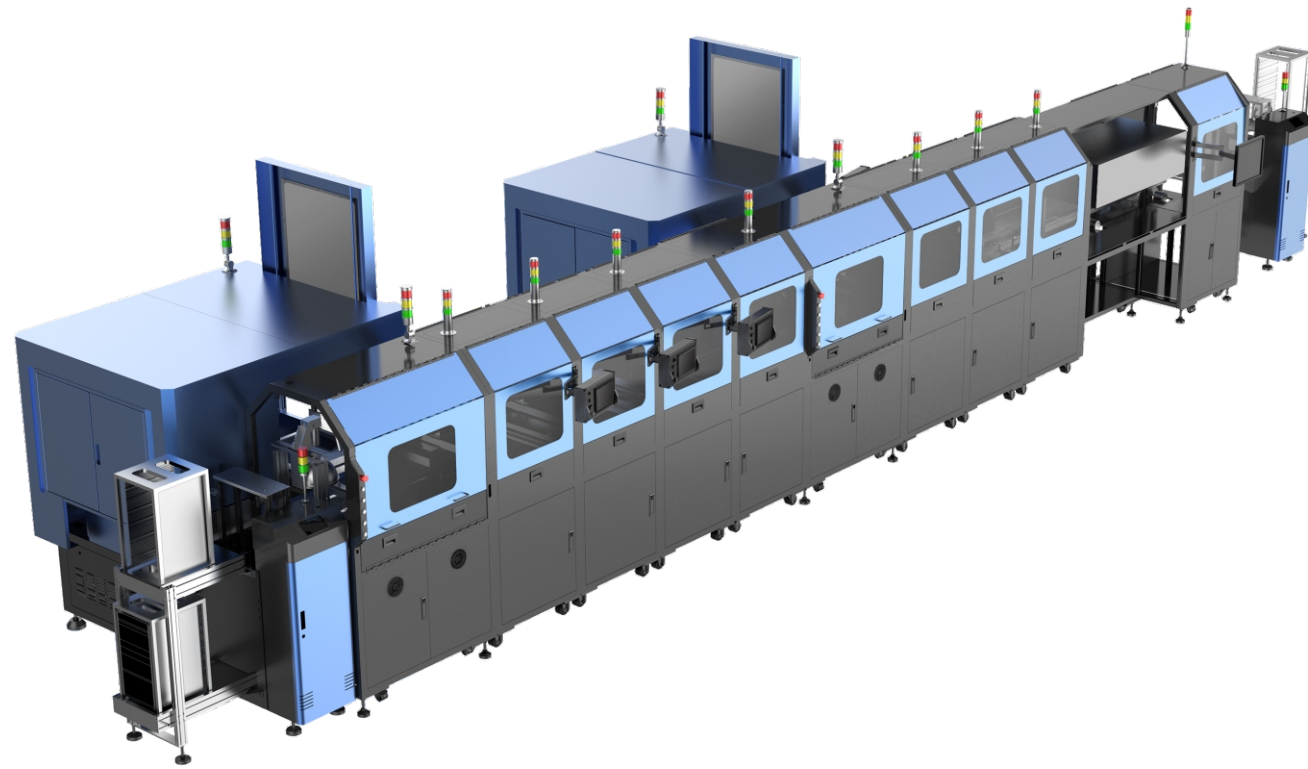

Equipment Feature 设备特点

- 设备采用单工站单机架模式，自由拼装设备数量匹配UPH。
- 设备采用方通焊接机架+气弹簧滚轮式开合门结构，外观大气。
- 左右产品切换采用免工具快换结构，左右板生产切换时间小于30min。
- 创新式的采用2900W相机精确拍照切割产品，生成DWG图形，500W CCD二次定位销孔，自动校正切割位置，最大效率利用激光器。
- The machine is modular design, and the modular free match to meet the UPH requirement.
- The machine is provided with the square welding frame + air spring roller type door and has an elegant appearance.
- The left/right board changeover time is less than 30min due to the adoption of tool-free fast-changeover structure.
- Photograph the cutting products with 2900W camera innovatively and precisely, generate DWG graphics, correct the cutting position automatically through 500WCCD secondary positioning pin hole and utilize the laser in maximum efficiency.

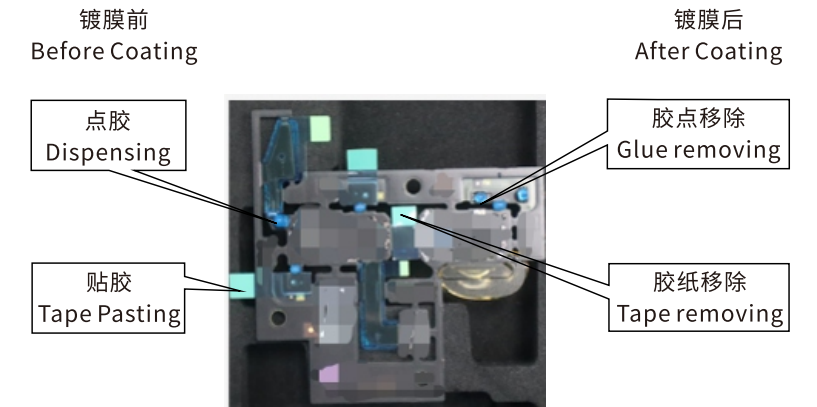
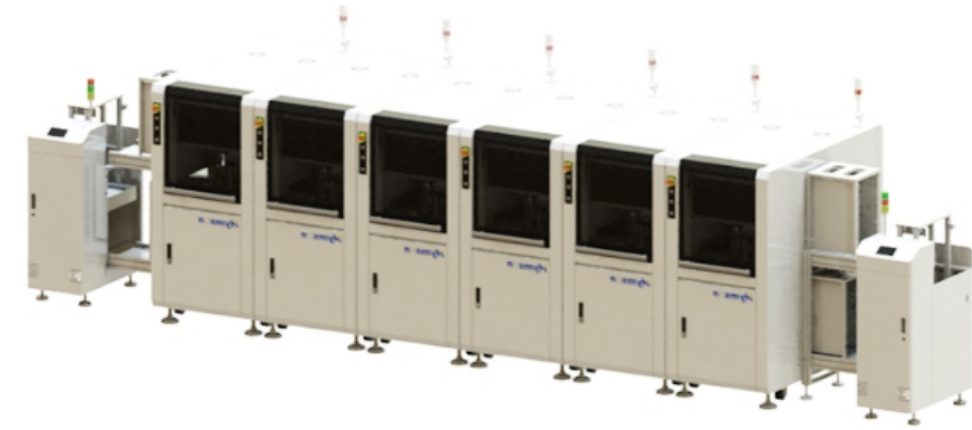

Parameters 产品参数

描述 Description	在PCB镀膜前,使用点胶及贴胶工艺,将需要保护的元器件进行遮蔽;镀膜后,利用激光切除及机械去除方式将胶纸及胶点去除。设备已经实现标准化,快速方便的进行工艺调整及工位扩展或升级;主要包含点胶机、贴标机、激光镭射切割机、胶纸移除机,AOI检测等设备。 Function: Before PCB coating, use dispensing and pasting process to shield the components for protection; After coating, the glue are removed by laser cutting and mechanical removal.The equipment has been standardized, and the process adjustment and station expansion or upgrading can be carried out quickly and conveniently; Mainly including dispensing machine, labeling machine, laser cutting machine, glue-removal machine, AOI testing equipment.
UPH	≥400PCH/H(可增加设备提高UPH Increase equipment to improve UPH)
MTBA	≥60Min
MTBF	≥168H
额定电压 Rated Voltage	AC220V
气压 Air Pressure	0.5MPa~0.7MPA
设备尺寸 Machine Dimension	L15200mm x W2200mm x H2100mm

VCM马达自动组装线

Automatic Assembly Line
of VCM Motor



Equipment Feature 设备特点

- 设备采用单工位单机架模式，柔性程度高，自由拼接机台数量匹配UPH。
- 设备采用方通焊接机架，外观大气，结构稳定。
- 全部工位配备CCD定位精度和产品兼容性高，整线切换已有型号产品生产的时间<2h。
- 设备采用XY轴拆分式设计，提高设备整体定位精度。
- The equipment has modular design with high flexibility, free match to meet the UPH requirement.
- The square welding rack of equipment is elegant in appearance and stable in structure.
- All stations are equipped with CCD, with high positioning accuracy, and the line changeover time is less than 2h.
- The X and Y axis split design improves the overall positioning accuracy of machine.

Parameters 产品参数

描述 Description	此设备用于VCM的定子、动子和总装。采用标准化模块设计，方便调整、扩展工位。主要包含弹簧片组装、磁石组入、点胶、热铆、激光焊接、激光焊锡、激光切割等。 The machine is applied for stator, rotor and final assembly of VCM. Standardized module design is adopted to facilitate the adjustment and expansion of the station. It mainly includes spring assembly, magnet assembly, dispensing, hot riveting, laser welding, laser soldering, laser cutting, etc.
UPH	≥1200PCH/H(可增加设备提高UPH Can raise UPH by increase equipment)
MTBA	≥30Min
MTBF	≥168H
额定电压 Rated Voltage	AC220V
气压 Air Pressure	0.5MPa~0.7MPa
设备尺寸 Machine Dimension	L8000mm×W1900mm×H2300mm(定子段 The stator section) L12800mm×W1900mm×H2300mm(动子段 The rotor section) L15800mm×W1900mm×H2300mm(总装段 Assembly section)

纽扣电池电芯组装线

Button Battery Cell Assembly Line

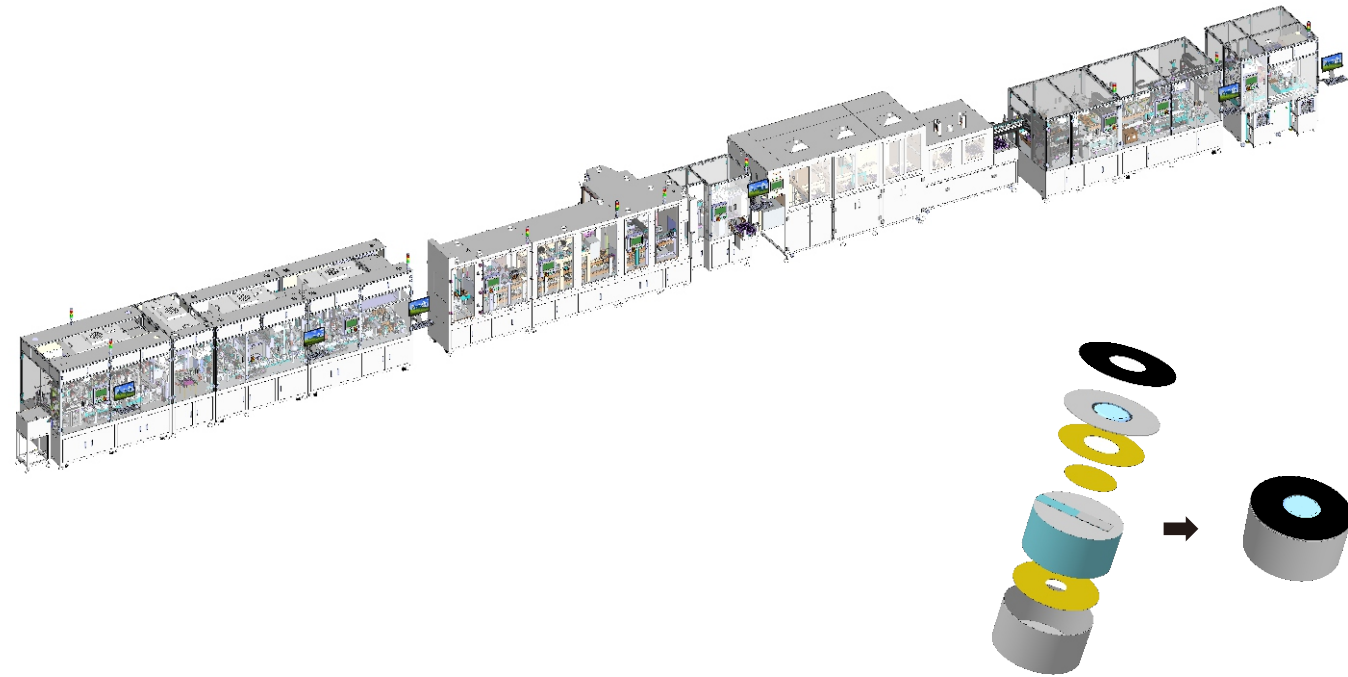

Equipment Feature 设备特点

- 适用于钢壳纽扣电池的全自动组装制造，能兼容直径8-16mm的电池。
- 工艺流程: 主要包含正负极耳焊接，电芯入壳，注液，封口焊接，短路测试，AOI焊缝检测，漏液检测等工艺。
- Suitable for the manufacture of steel shell button shape batteries, compatible with various sizes of 8-16mm diameter.
- Process flow: Welding the negative tab to shell, inserting the battery cell into the shell, welding the positive tab with the cover, inspection and weighing, electrolyte injection, cover sealing welding, electrolyte leakage detection, welding NG detection.

Parameters 产品参数

尺寸 Size	L14m x W1.6m x H2.1m
效率 Efficiency	UPH:1200-3000
良率 Yield	98.5% - 99.9% (单工站 Single station)
稳定性 Stability	Down Time <3% (整线 Whole line)

纽扣电池PACK线

Button Battery PACK Line

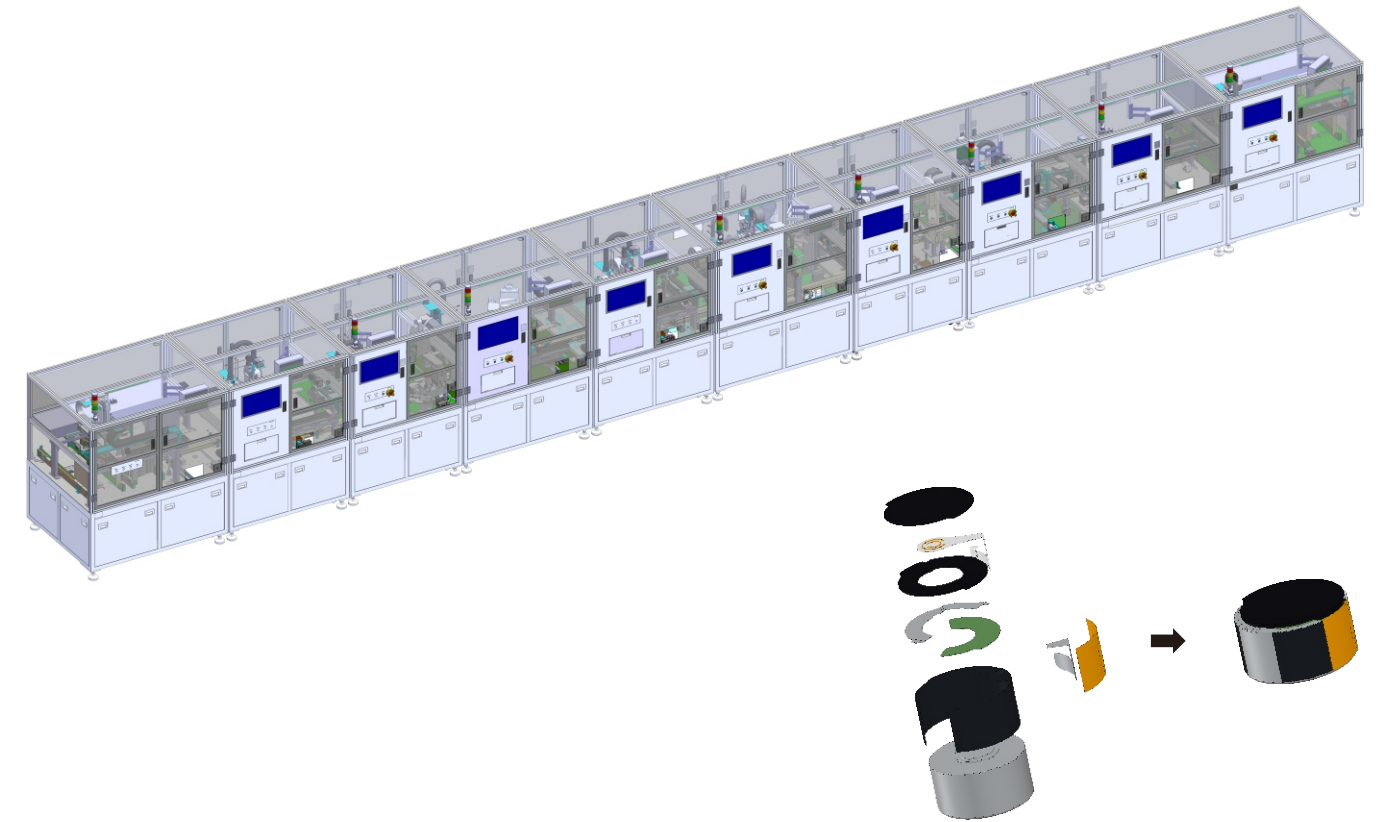

Equipment Feature 设备特点

- 适用于手表, 耳机等纽扣电池PACK工艺实现自动化。
- 涉及工艺: 自动上料及贴PSA胶&OCV、Busbar贴装&检测、Top面焊接&检测、Bottom面PSA贴装&检测、Busbar折弯&检测、Bottom面焊接、漏液检测、Bottom面贴防水胶&激光镭雕、取支架&功能测试、离线镀膜、自动上料及Top面贴防水胶、贴功能胶、功能测试&外观检测、PACK尺寸全检、自动入Tray。
- It is suitable for smart phone, watch, headset, pad and other battery pack process automation.
- Process: Auto loading and pasting PSA & OCV test, Busbar assy & testing, Top surface welding & testing, Bottom PSA pasting & testing, Busbar bending & inspection, Bottom surface welding, Leakage inspection, Bottom surface waterproof glue pasting & Laser Engraving, Bracket & function test, Off line coating, Auto loading and top surface waterproof glue pasting, Pasting functional glue, Function test & cosmetic inspection, Pack size inspection, Auto unload to tray.

Parameters 产品参数

尺寸 Size	L19.5m x W1m x H1.82m
效率 Efficiency	UPH1200 (整线输出 Whole line output)
良率 Yield	99.9% (单工站 Single station)
稳定性 Stability	Down time <2% (整线 Whole line)

软包电池PACK线

Battery PACK Line

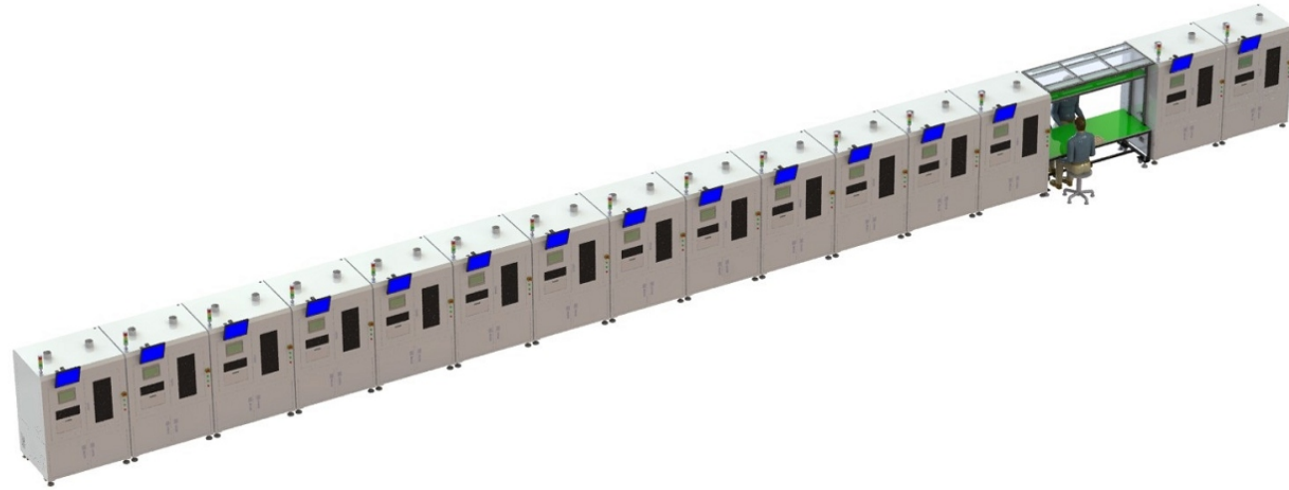

Equipment Feature 设备特点

- 适用于手机, 手表, 耳机, PAD等软包电池PACK工艺实现自动化。
- 涉及工艺: 移印、喷码、OCV测试、贴凹槽胶、极耳成型裁切、极耳平整、极耳长度检测、PCM组装、PCM激光焊接、焊点检查、贴极耳胶、极耳折弯、极耳成型、贴外观胶、裹外观胶、外观胶成型、功能&GG测试、连接器检查、APMT、漏液检查、人工外观检查、图像采集。
- It is suitable for smart phone, watch, headset, pad and other soft battery pack process automation.
- Process: Pad printing, Inkjet, OCV test, Terrace insulator sticking, Tab Z-bending&cutting, Tab flattening, Tab length inspection, PCM & cell assembly, PCM laser welding, Welding point inspection, Tab adhesive sticking, PCM Tab bending, PCM Tab forming, Cosmetic tape sticking-Cosmetic tape wrapping, Cosmetic forming, Function & GG test, Connector inspection, APMT, Leakage test, Visual inspection by manual-Picture Capture.

Parameters 产品参数

尺寸 Size	L26.5m x W1.5m x H1.9m
效率 Efficiency	UPH850 (整线输出 Whole line output)
良率 Yield	99.9% (单工站 Single station)
稳定性 Stability	Down time < 2% (整线 Whole line)